

Table of Contents

- MCF-LW12TER Operating Manual** 1
- 1. Description** 1
- 2. Overview** 2
 - 2.1 Technical data 2
 - 2.2 Installation 3
 - 2.3 Power ON/OFF 4
 - 2.4 System leds 6
 - 2.5 Battery 6
 - 2.6 Firmware update 9
- 3 LEDs** 12
- 4. Measures** 12
 - 4.1 Period 13
 - 4.2 Temperature 13
 - 4.3 Pressure 13
 - 4.4 Humidity 14
- 5 LoRaWAN network** 14
 - 5.1 Activation 15
 - 5.2 Other settings 16
- 6 Passwords** 17
- 7 Configuration file** 20
 - 7.1 Multi devices configuration 21
- 8 LoRaWEB Tool** 22
- 9 Payload** 23
- 10 Ordering code** 23
- 11 Declaration of conformity** 23
- 12 Contacts** 23



MCF-LW12TER Operating Manual

Important safety information



Read this manual before attempting to install the device! Failure to observe recommendations included in this manual may be dangerous or cause a violation of the law. The manufacturer will not be held responsible for any loss or damage resulting from not following the instructions of this operating manual.

- Do not dismantle or modify in any way.
- The device is only intended for indoor use. Do not expose it to moisture.
- The device is not intended to be used as a reference sensor, and enginko Srl will not be held liable for any damage which may result from inaccurate readings.
- Avoid mechanical stress
- Do not use any detergent or alcohol to clean the device.

Disposal information for users



Pursuant to and in accordance with Article 14 of the Directive 2012/19/EU of the European Parliament on waste electrical and electronic equipment (WEEE), and pursuant to and in accordance with Article 20 of the Directive 2013/56/EU of the European Parliament on batteries and accumulators and waste batteries.

The barred symbol of the rubbish bin shown on the equipment indicates that, at the end of its useful life, the product must be collected separately from other waste.

Please note that the lithium batteries must be removed from the equipment before it is given as waste and disposed separately. To remove the batteries refer to the specifications in the user manual. For additional information and how to carry out disposal, please contact the certified disposal service providers.

1. Description

The MCF-LW12TER is a battery powered sensor for indoor applications that reads temperature, relative humidity and barometri pressure. The device sends collected data over the LoRaWAN® network. Ideally suited for a wide range of applications such as home buildings, air quality monitoring and energy saving applications.



2. Overview

2.1 Technical data

- Cortex M0 + CPU
- EEPROM 32Kb
- 64k flash
- AES 128 bit encryption
- LoRaWAN® stack class A 1.0.2 EU868, AS923, AU915 and US915
- Temperature -10 ÷ 60°C (± 1.0°C, ± 0.5°C @ +25°C)
- Humidity 0 ÷ 100% (20 ÷ 80% ± 3% @ 25°C, 0 ÷ 20% * 80 ÷ 100% ± 5% @ 25°C)
- Pressure 300 ÷ 1100hPa (± 1hPa)
- Battery powered with 6 years of battery life (SF = 12, 10 minutes reading period)
- Battery capacity (included) 14400mAh
- NFC for node configuration, FW update and data reading
- Indoor installation
- Storage temperature -20 + 80°C
- Operating temperature -10 + 60°C
- Dimensions: 80x80x25mm
- Weight ~ 150g

2.2 Installation

To ensure correct operation and reliable and consistent measurements, install the MCF-LW12TER sensor away from direct sunlight and heating sources like radiators, conveyors, TV, lights etc. and far away from doors and windows.

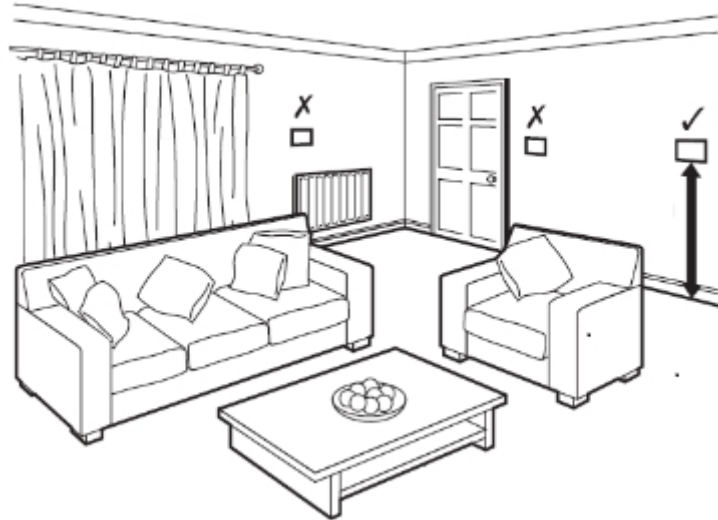

The device must be placed where the LoRaWAN® signal coverage is good (SF = 7 optimal, SF = 12 weak). The sensor must be installed vertically on a wall at about 1.5mt height. It must be at least 30cm away from metal objects, and 1mt away from electronic devices.

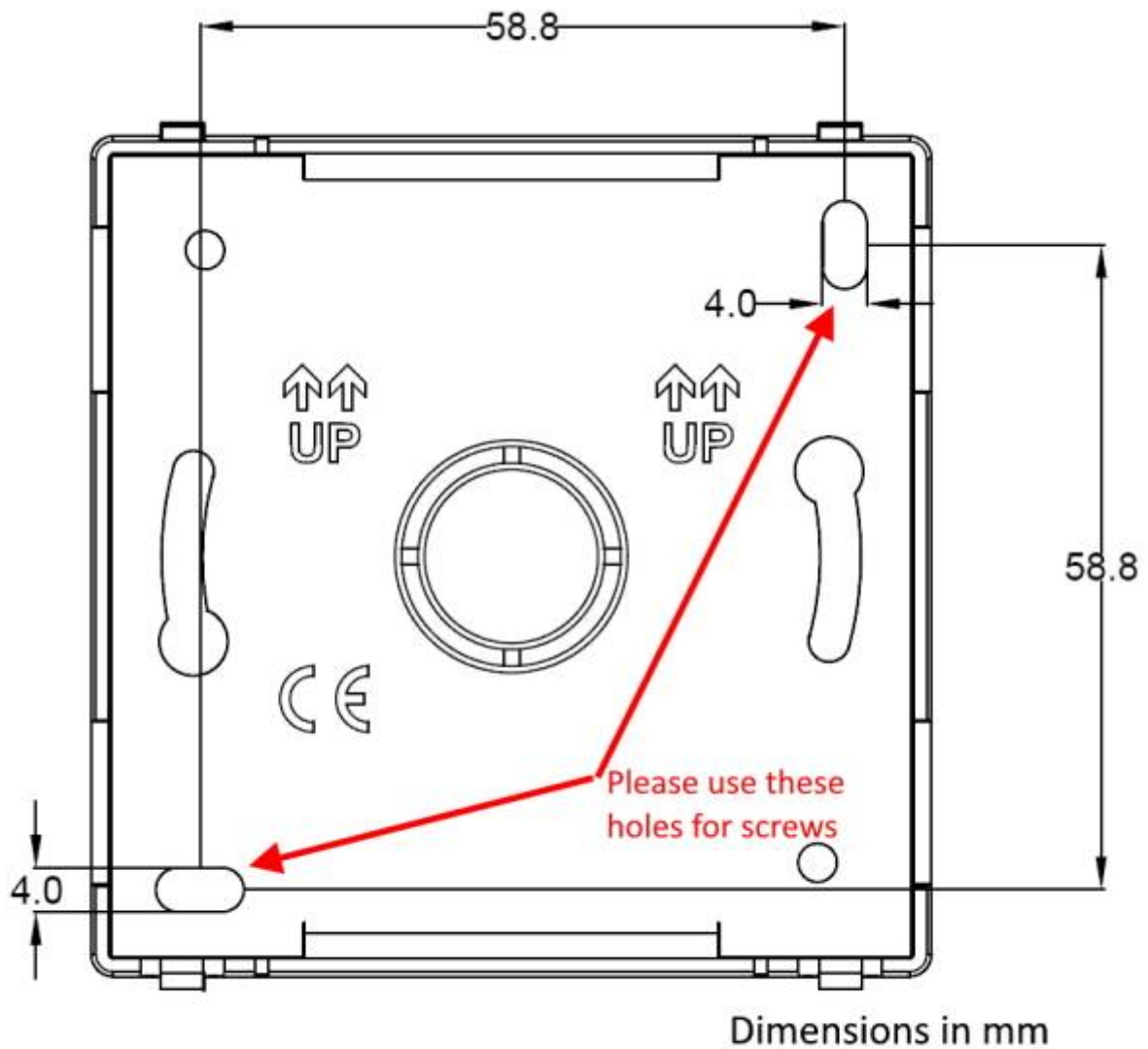

2.2.1 LoRa Tool

To deploy the sensor, download the latest **LoRa Tool** Android App to setup LoRaWAN credentials and other preferences :



Always validate your settings by reading the NFC data after the sensor has restarted.

2.3 Power ON/OFF

The sensor is shipped completely off to prevent battery consumption during storage. It is therefore necessary to carry out a first power-on prior to commissioning.

There are two ways to power on the sensor:

- With NFC: Move the NFC antenna of the mobile (the exact position varies depending on the model of the smartphone) to the sensor antenna, in the area shown in the figure:



- Mechanical power on:

Open the case using a screw driver as follow:



By using a screw driver push button for 1s as follow, moving right:



Close the plastic case. Switch-on is visible by flashing of red and green leds.

In case of long period inactivity, if necessary, is possible to shut-off again the sensor to prevent battery consumption, via downlink or with LoRa Tool App:



2.4 System leds

LoRaWAN® not configured		Slow flashing
Joining		Quick flashing
Sending		Quick flashing
Receiving		Quick flashing
Steady state		Fixed
Data error		Flashing 2 seconds
Connection error		Flashing 1 second

2.5 Battery

This sensor contains lithium battery, which must be disposed of separately.

MCF-LW12TER is provided with one Li-SOCI2 battery packs:

Code	Description
MCF-1S4PE	14400mAh battery pack

This is the estimated battery life (in **years**) in the worst conditions:

	10min reading	15min reading	30min reading
SF12	7	10	> 10
SF7	> 10	> 10	> 10

2.5.1 Battery replacement

- remove the back panel of the sensor with a small screwdriver:



- detach the batteries from the electronic board (batteries are secured with dual locking tape) and disconnect from the connectors:

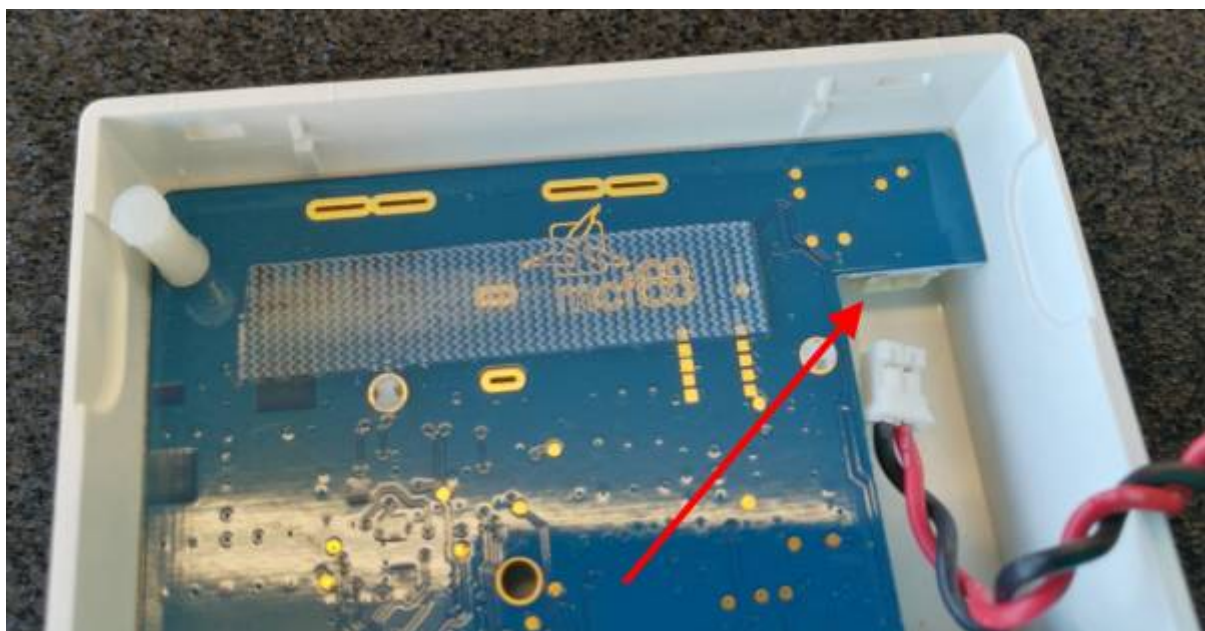

- Connect the new batteries and put them in place (replace the tape if needed):



- Place the rear panel paying attention to the wires.

After the batteries replacement, internal counters need to be resetted.

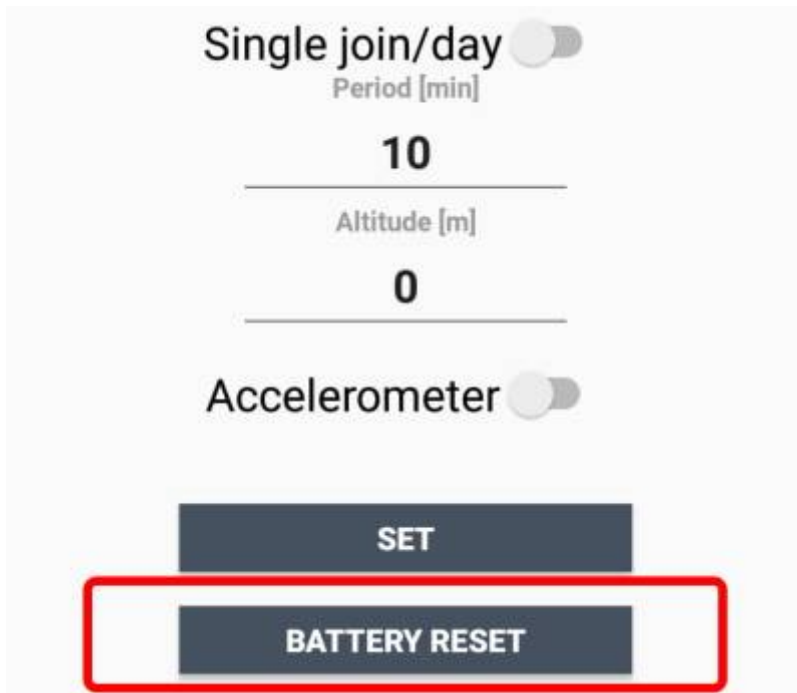

To perform the operation, you need a unique reset code that must be requested to enginko (please provide the DevEUI of the sensor when you ask for that code):

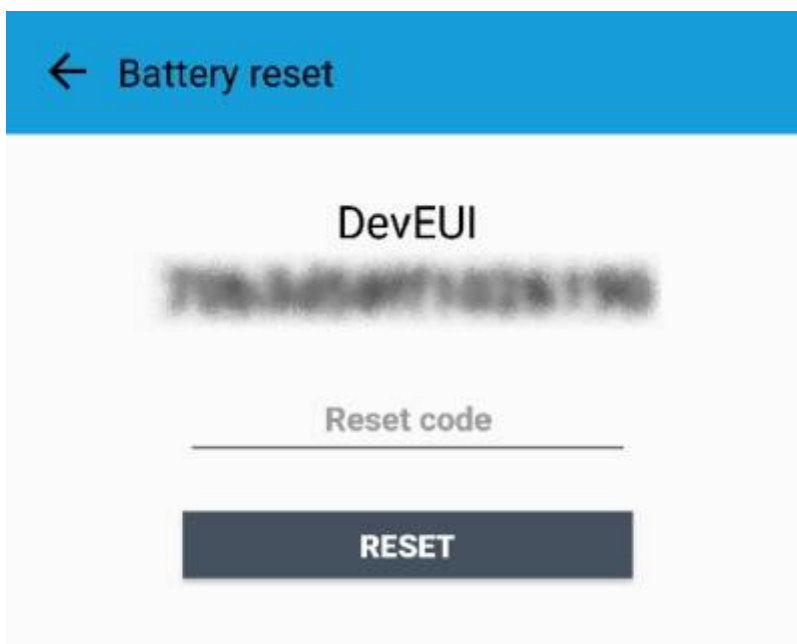

At the end of the procedure the battery level displays 100%.

2.6 Firmware update

Download the latest firmwares available on the smartphone with LoRaTool app:

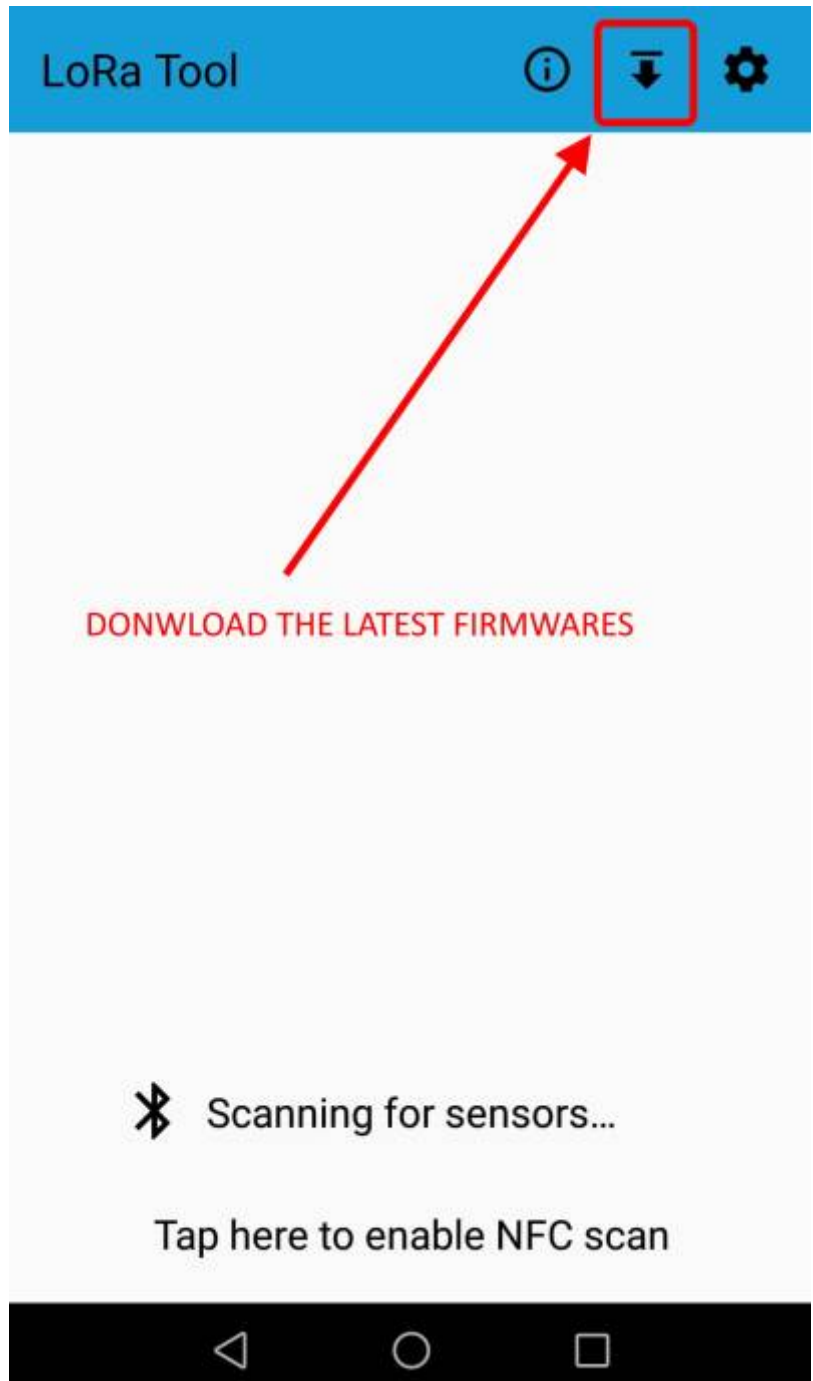

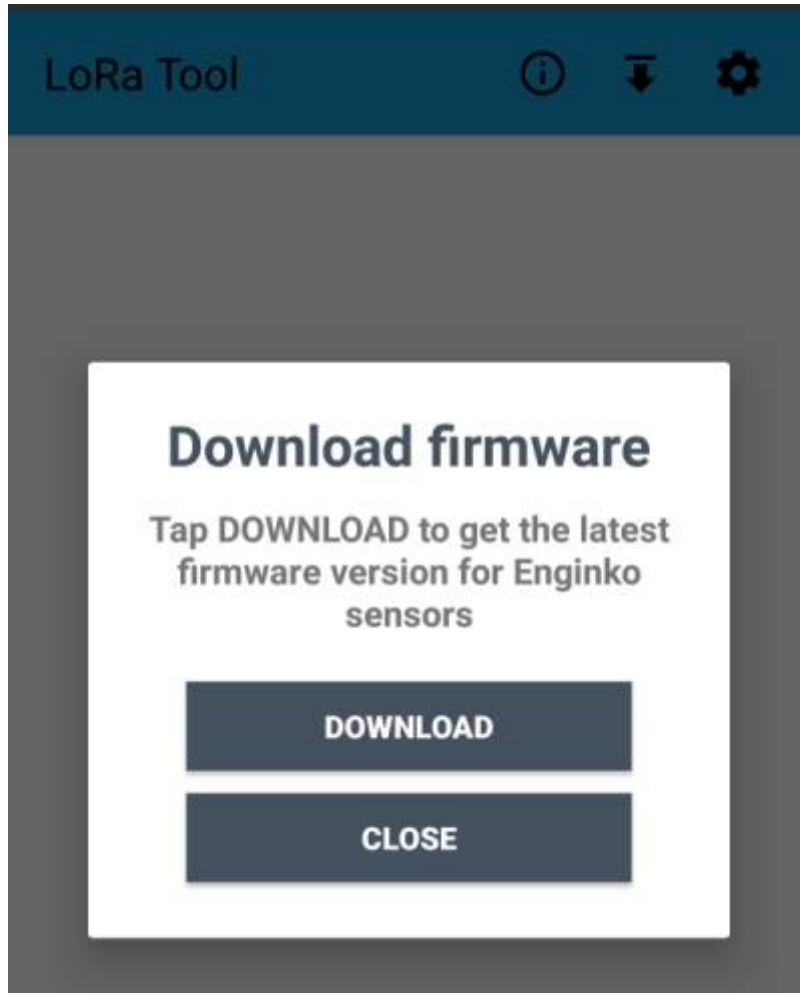

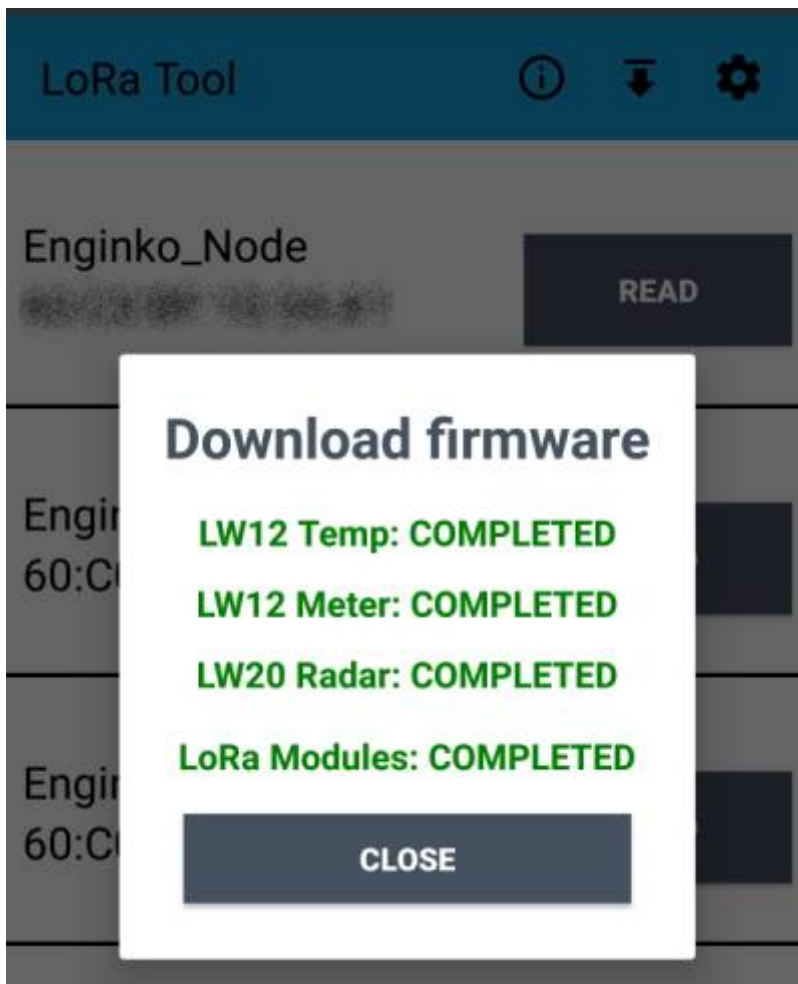

Update the sensor with LoRaTool:



During the update, do not move the smartphone until the end message.

3 LEDs

On the MCF-LW12TER there are two system leds, green and red.

4. Measures

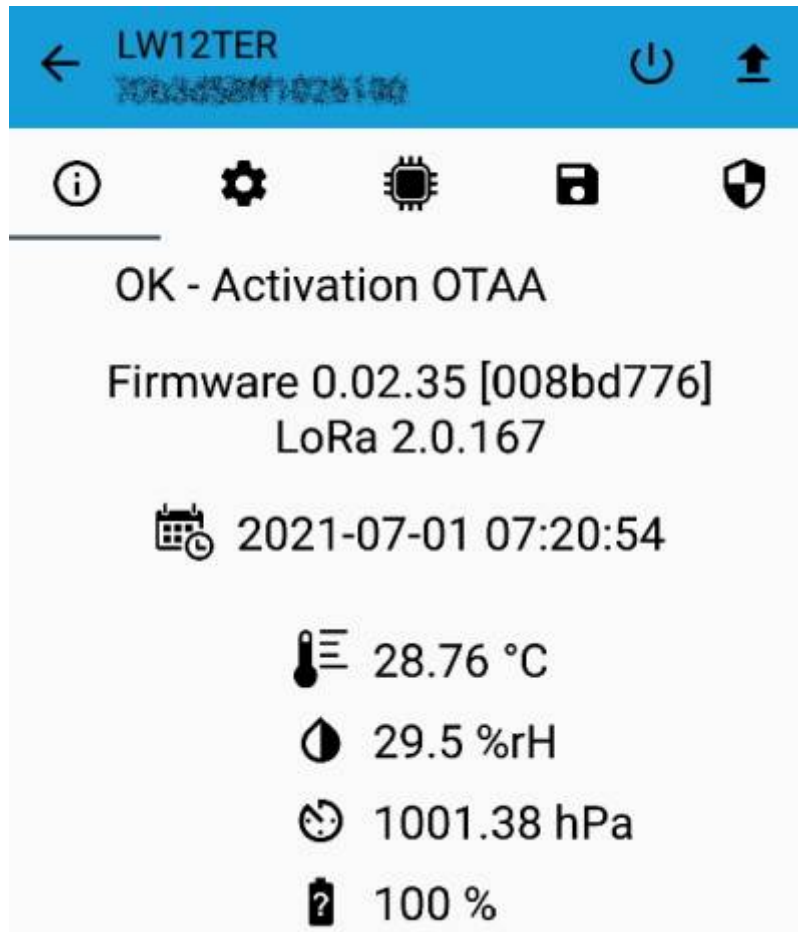

4.1 Period

Period is the interval (in minutes) between one measure and the next one. The sensor sends three measures for every transmission (each one with its own timestamp), so the messages interval is twice the period value. Value can be between 10 and 65535 minutes.

Period interval can be set with App or with downlink command.

The device sends extra reports when the measurement changes in accordance with the set thresholds.

4.2 Temperature

4.3 Pressure

4.3.1 Altitude compensation

When the sensor is not installed at the sea level, the reading of barometric pressures at other elevations must be compensated. Set the right altitude value with LoRa Tool app:

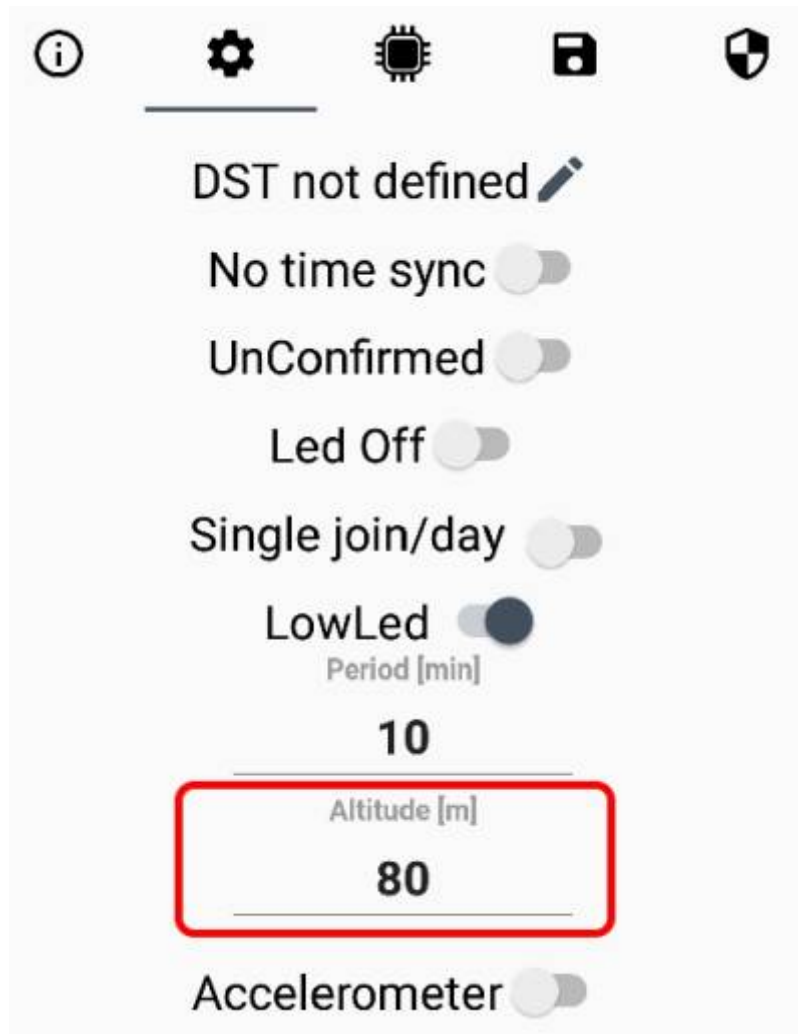

Value can be from -300 to 3000 meters.

Altitude can also be set with downlink command.

4.4 Humidity

5 LoRaWAN network

The sensor is compliant with LoRaWAN® **specification 1.0.2, regional 1.0.2b.**



5.1 Activation

The device supports the following activations on a LoRaWAN® network:

- 1. **NONE**: sensor not activated
- 2. **OTAA**: the JoinEUI and the AppKey not setted, must be written to the device;
- 3. **OTAA MCF88**: Over the air activation, fixed keys: JoinEUI = 904e915000000001, AppKey on request;
- 4. **OTAA ENGINKO**: Over the air activation, fixed keys: JoinEUI = 904e915000000001, AppKey on request;
- 5. **ABP**: requires writing to the device of NwkSkey, AppSkey, DevAddr.

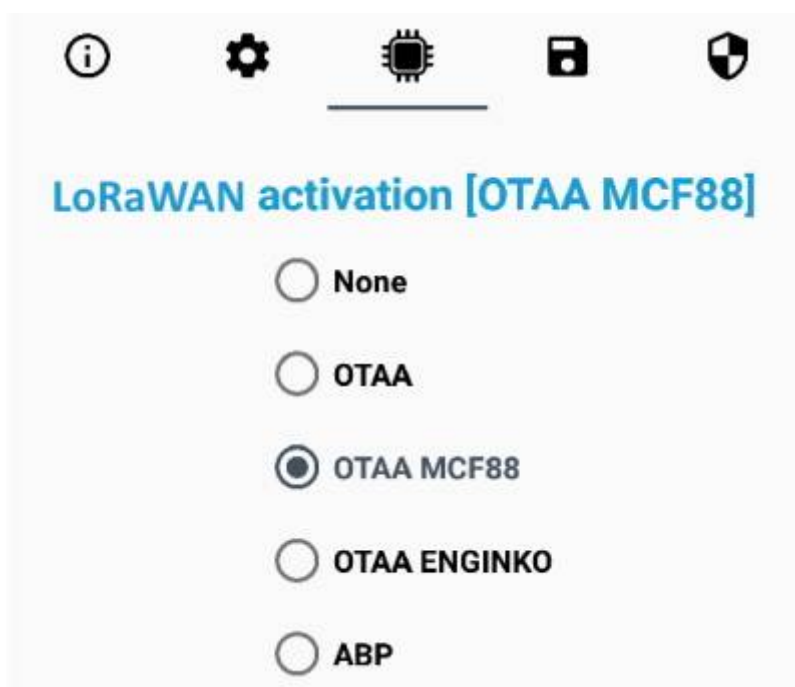

The device exits factory activated with **NONE** mode. On request devices can be shipped already activated.

Note: in **OTAA** AppKey is write only, in reading the field will always be empty, even if set.

5.2 Other settings

Network settings:

please keep "Any" settings. Change it only if Objenious network is used (default_ any).

Network type:

LoRa syncword can be setted as "private"(0x12) instead "public" (0x34), but the NS must be setted accordingly (default: public).

Band:

select the right LoRaWAN ® band settings accodngly to country requirements.

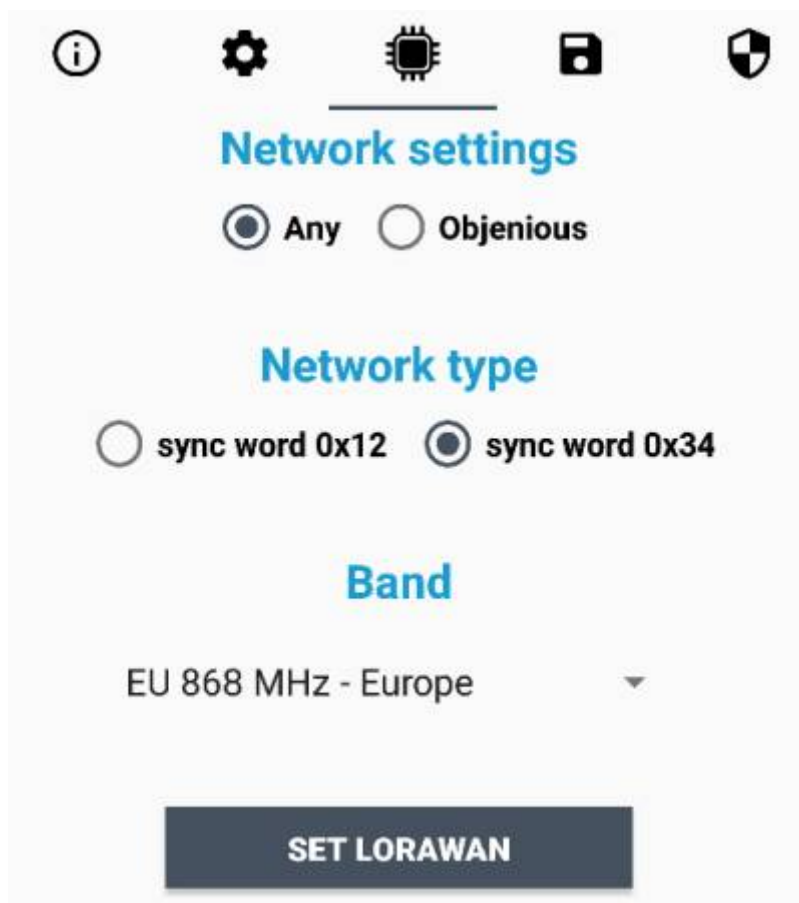

DST:

set to change DST (default: none).

No time sync:

set to disable time synchronization request (default: enabled).



Normally sensor asks for a time sync at every power on (uplink starting with 01) or, if enabled, once a week.

If not handled in the right way can cause a unnecessary battery consumption (battery life < 2 years).

Please check chapter 2.1 [DATA FRAME FORMAT](#).

UnConfirmed:

set for unconfirmed uplinks (default: confirmed uplink).

Single join/day:

set for to allow only one join per day (default: multiple join allowed).



6 Passwords

The device can be protected by passwords, to avoid unauthorized persons to read data or modify parameters.

As default passwords are equal to 0.

Allowed values range from 0 to 99999999 (only numbers).

To change the passwords, set the new values with the LoRa Tool App:

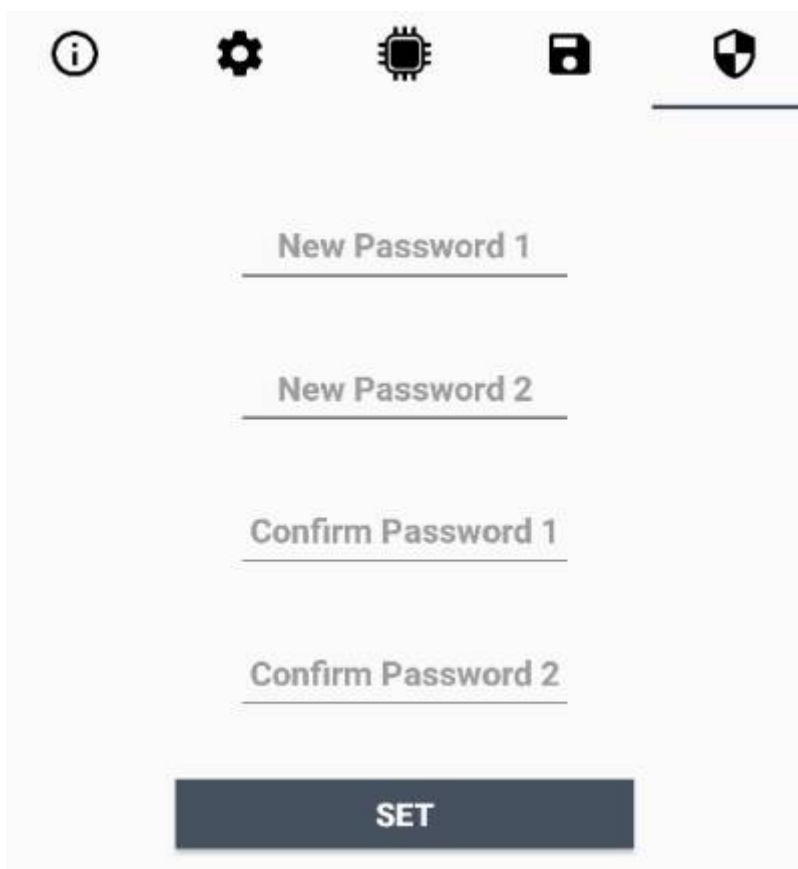

Once the passwords are setted, to gain access from LoRa Tool to the sensor, open the App:

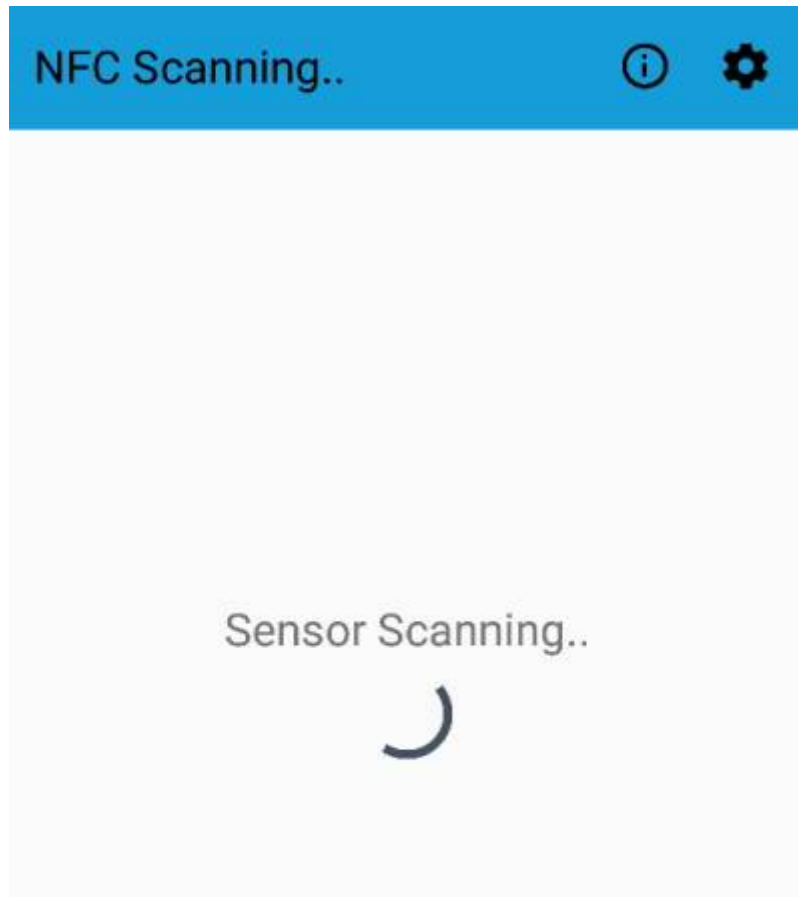

and set the right values before reading from the device:

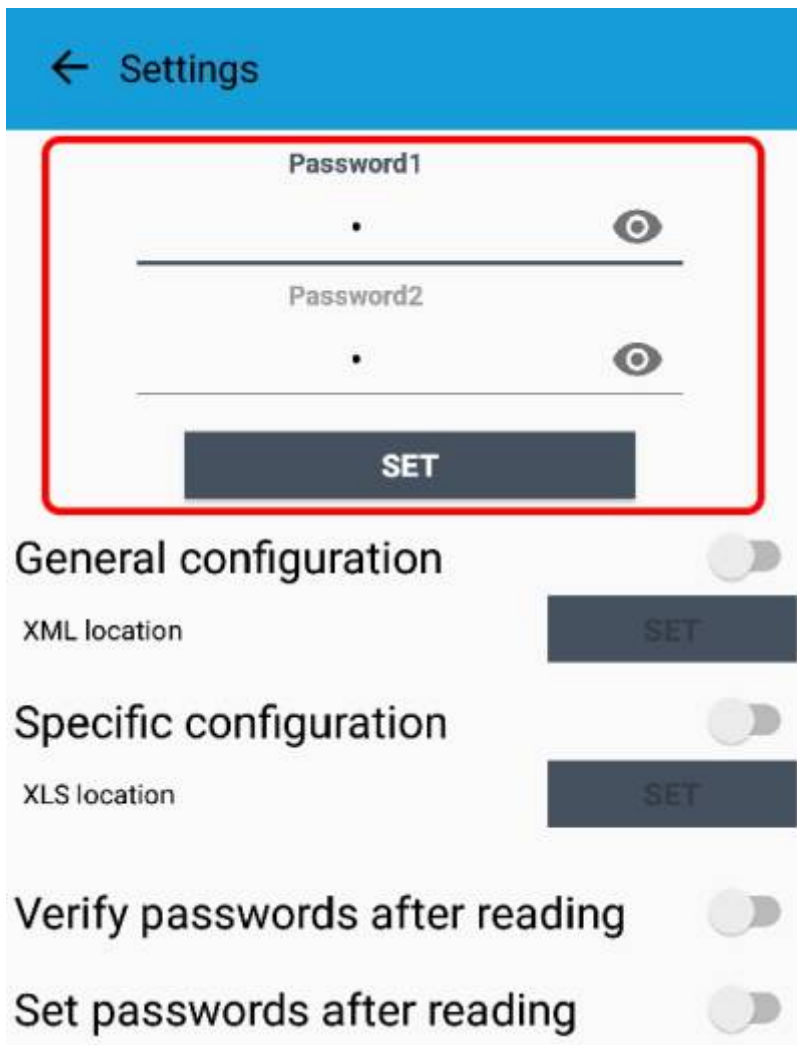

To bring back the sensor to factory default and reset the passwords, a reset code must be requested to enginko (please provide the DevEUI of the sensor when you ask for that code).

7 Configuration file

With LoRa Tool App is possible to configure the device using an XML file, instead to manually adjust the parameters (for details about the file format please ask to enginko). This is very useful especially in case of multiple devices configuration.

With “Save” button an XML file with the actual configuration of the sensor will be generated. This is useful to store or clone the configuration, or to send it to enginko's support if needed.



7.1 Multi devices configuration

With LoRa Tool App is possible to configure many devices in an easy way.

For multi-configuration is needed at least one XML file with the parameters to set.

Settings on this file will be applied to all the sensors.

With an additional XLS file is possible to load different LoRa configuration parameters (Activation Type, AppKey, AppEUI, NetKey, DevAddress, Band, Private option) for each sensor, based on DevEUI.

When the sensor is approached, if one parameter is different from files, the APP will ask you if you want to overwrite.

XLS is prevailing on the XML, so if both files are enabled, if the DevEUI of the device matches one of the DevEUIs in the XLS file, LoRa parameters will be setted from this one. one.

These configuration can be done in the in the Settings:

- Enable or disable the use of the general configuration by file;
- Enable or disable the use of the specific configuration by file;
- Verify the passwords;
- Writing the passwords.

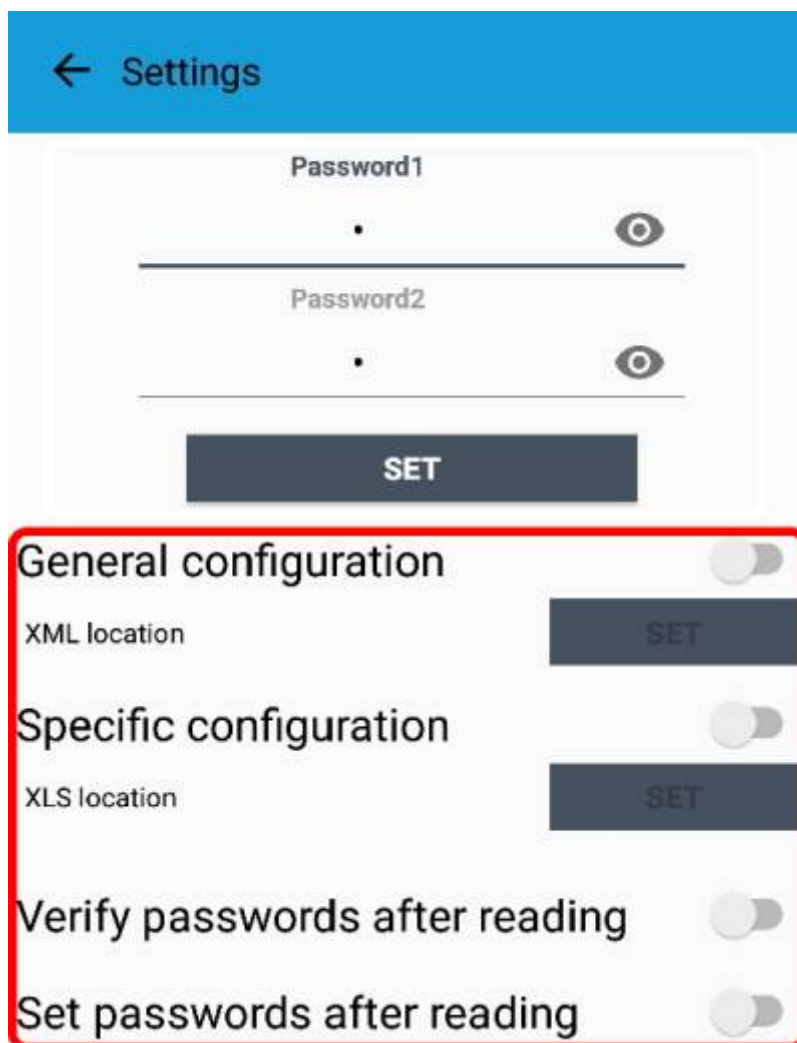

For details on files format please ask to enginko.

8 LoRaWEB Tool

enginko provides, upon free registration, **LoRaWEB** online tool, where for each sensor it is possible to find documentation, javascript examples for parsing, downlink generator and uplink decoder:

[LoRaWEB Tool](http://iot.mcf88.cloud/LoRaWeb) (iot.mcf88.cloud/LoRaWeb)

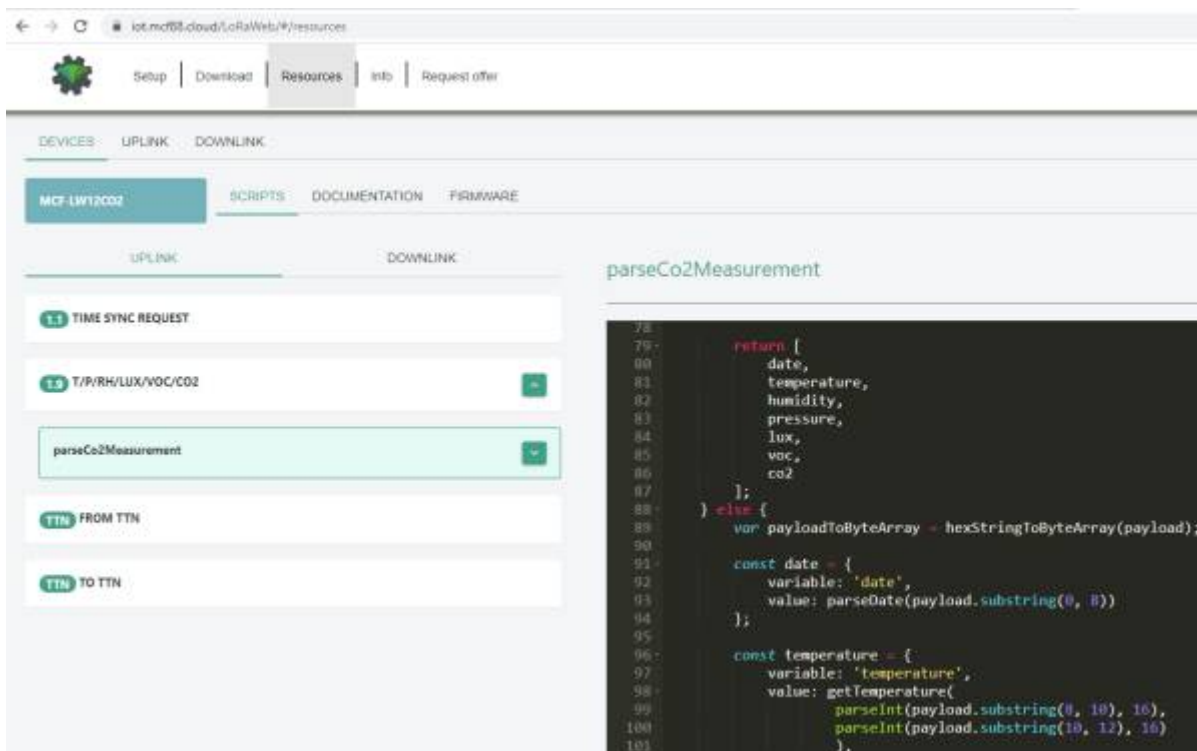
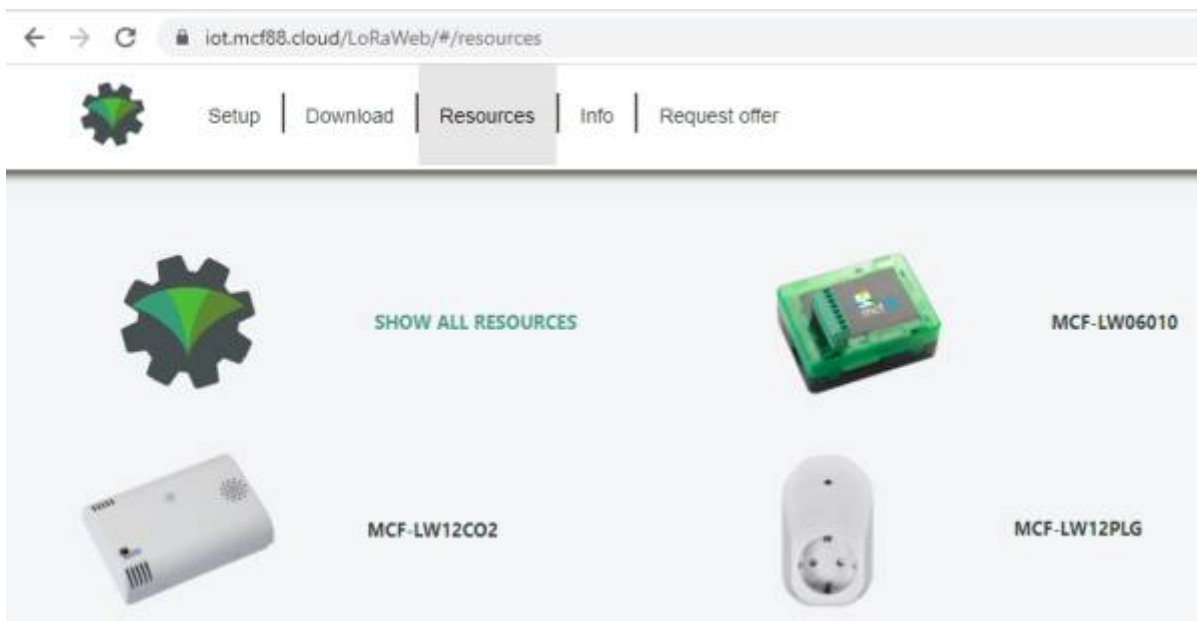

9 Payload

For payload descriptions, uplinks and downlinks format and available commands please refer to this document:

[DATA FRAME FORMAT](#)

10 Ordering code

Code	Description
MCF-LW12TER	enginko LoRaWAN® indoor environmental EU863-870
MCF-LW12TER-AS	enginko LoRaWAN® indoor environmental sensor AS920-925
MCF-LW12TER-US	enginko LoRaWAN® indoor environmental sensor US902-928
MCF-LW12TER-AU	enginko LoRaWAN® indoor environmental sensor AU915-928

11 Declaration of conformity

Hereby, enginko Srl declares that MCF-LW12TER complies with the essential requirements and other relevant provisions of Directive 2014/53/EU.

12 Contacts

enginko Srl

Via Roma 3 I-28060 Sozzago (NO)

T : +39 0321 15 93 088

E : info@enginko.com

PEC: enginkosrl@legalmail.it

W: enginko.com

Rev.1

From:

<http://www.enginko.com/support/> - **enginko.support.center**

Permanent link:

http://www.enginko.com/support/doku.php?id=manual_mcf-lw12ter&rev=1685338420

Last update: **2023/05/29 07:33**

