

# Table of Contents

- MCF-LW06424 Operating Manual** ..... 1
- 1. Description** ..... 1
- 2. Overview** ..... 2
  - 2.1 Technical data ..... 2
- 3 Installation** ..... 3
  - 3.1 Connection ..... 3
  - 3.2 Analog inputs ..... 4
  - 3.3 Configuration ..... 6
  - 3.4 System led ..... 7
  - 3.5 Firmware update ..... 8
- 4. Setup** ..... 8
  - 4.1 Period ..... 8
  - 4.2 Thresholds ..... 9
  - 4.3 Other settings ..... 10
- 5. Diagnostic** ..... 11
- 6 LoRaWAN network** ..... 11
  - 6.1 Activation ..... 12
  - 6.2 Other settings ..... 13
- 7 Passwords** ..... 13
- 8 General configuration file** ..... 14
  - 8.1 Multi devices configuration ..... 15
- 9 Payload** ..... 16
- 10 Ordering code** ..... 16
- 11 Declaration of conformity** ..... 16
- 12 FCC compliance for MCF-LW06424-US** ..... 16
- 13 Contacts** ..... 17





# MCF-LW06424 Operating Manual

## Important safety information



Read this manual before attempting to install the device! Failure to observe recommendations included in this manual may be dangerous or cause a violation of the law. The manufacturer will not be held responsible for any loss or damage resulting from not following the instructions of this operating manual.

- Do not dismantle or modify in any way.
- Avoid mechanical stress
- Do not use any detergent or alcohol to clean the device.

## Disposal information for users



**Pursuant to and in accordance with Article 14 of the Directive 2012/19/EU of the European Parliament on waste electrical and electronic equipment (WEEE), and pursuant to and in accordance with Article 20 of the Directive 2013/56/EU of the European Parliament on batteries and accumulators and waste batteries.**

The barred symbol of the rubbish bin shown on the equipment indicates that, at the end of its useful life, the product must be collected separately from other waste.

Please note that the lithium batteries must be removed from the equipment before it is given as waste and disposed separately. To remove the batteries refer to the specifications in the user manual. For additional information and how to carry out disposal, please contact the certified disposal service providers.

## 1. Description

MCF-LW06424 is able to read 4 analog inputs 4-20mA with a resolution of 12 bit. The inputs have an insulation of 1000Vdc with respect to the power supply, and are protected against polarity inversion.



MCF-LW06424 is available with DIN rail option (MCF-DIN105):



## 2. Overview

### 2.1 Technical data

- CPU Cortex M4
- RTC
- EEPROM 32KB
- Flash 1MB
- Encryption AES 128 bit
- LiPo 800mAh rechargeable battery
- Class C LoRaWAN® stack EU868, AS923, AU915, US915

- 1000Vdc isolated analog inputs
- 4 analog voltage inputs 4-20mA 12bits
- 4 programmable thresholds for each channel
- Integrated termination and polarization resistors
- USB On The Go
- IoT node setup and firmware upgrade via USB interface
- Power supply 10÷36Vdc
- Storage temperature range -20°C ÷ +80°C
- Working temperature range -10°C ÷ +70°C
- Dimensions L x H X P: 81 x 60 x 50mm

## 3 Installation

### 3.1 Connection

#### 3.1.1 Power connection as stand-alone device

Please refer to following connections:



pin	Name	Description
J3.9	GND	Negative power supply (BLACK)
J3.10	VDD	Positive power supply range [10-36Vdc] (RED)

Power can also be supplied by USB.

#### 3.1.2 Power connection with DIN rail option

Please refer to following connections:



Power supply:

Pin	Name	Description
J2.1	Vdc	Positive power supply range [10-36Vdc]
J2.2	GND	Negative power supply

Power can also be supplied by USB.

### 3.1.3 Antenna

The magnetic antenna must be positioned on a metal body. It should preferably be vertical and at least 30 cm away from other metal bodies. The installation must take place in a place where the LoRaWAN® signal coverage is good (SF=7 optimal, SF=12 weak). Use the provided clip to hold the antenna connector in place, as in the picture:



### 3.2 Analog inputs



Pin	Name	Description	Range	Resolution
J1.1	AI1	Analog input 1	4-20mA	12 bit
J1.2	GA	Common		
J1.3	AI2	Analog input 2	4-20mA	12 bit
J1.4	GA	Common		
J1.5	AI3	Analog input 3	4-20mA	12 bit
J1.6	GA	Common		
J1.7	AI4	Analog input 4	4-20mA	12 bit
J1.8	GA	Common		
			<b>Current Loop (4-20mA)</b>	
Input resistance			125Ω	
Absolute maximum value			24mA	
Max error			±0.1%	
Insulation			1000Vdc	

Current values less than 3mA generate a “disconnected sensor” condition.

**Caution:** inputs are not galvanically isolated from each other.

### 3.2.1 Connection examples

1 sensor

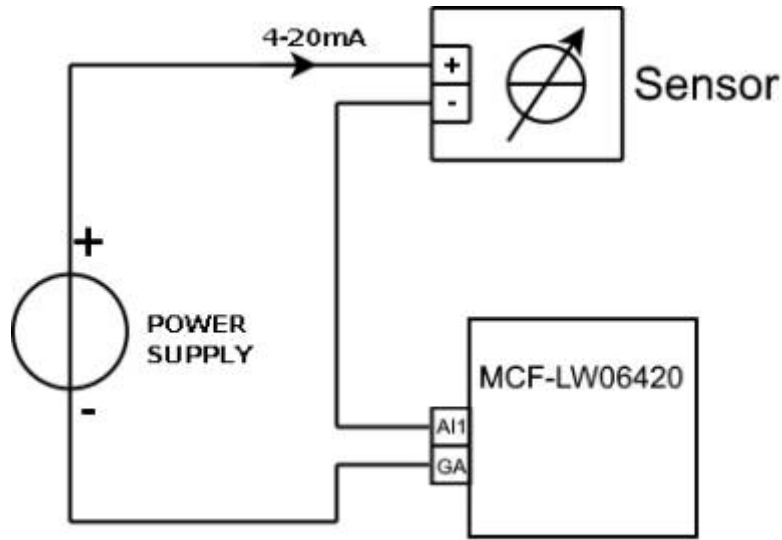

## 2 sensors



## 3.3 Configuration

To deploy the sensor, use **LoRaWEB** online tool, to setup LoRaWAN® credentials and other preferences (only available for Windows®) :

[LoRaWEB Tool](https://iot.mcf88.cloud/LoRaWeb) (iot.mcf88.cloud/LoRaWeb)

Before connect the device the first time, please install LoRaBridge applications and drivers:

<https://iot.mcf88.cloud/LoRaWeb/#/download>

Validate your settings reading data after the write.

enginko provides, upon free registration, user manuals, javascript examples, downlink generator, uplink decoder, firmware updates and different tools :



### 3.4 System led

LoRaWAN® not configured		Slow flashing
Joining		Quick flashing
Sending		Quick flashing
Receiving		Quick flashing

Steady state		Fixed
Data error		Flashing 2 seconds
Connection error		Flashing 1 second

### 3.5 Firmware update

Save the new firmware file (.exe) on the PC, run the file, select the USB FW port and start the update:



and waiting for the end message.

## 4. Setup

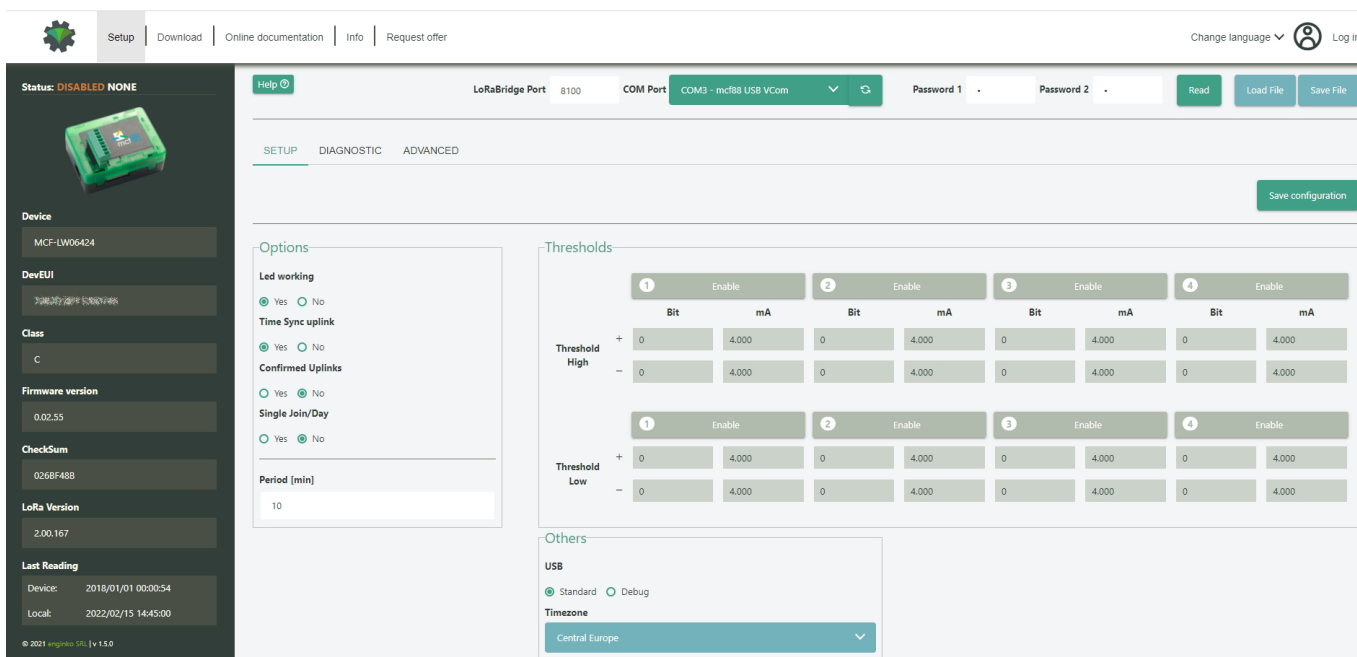

### 4.1 Period

Period is the interval (in minutes) between one measure and the next one. The sensor sends one

measures for every transmission. Value can be between 15 and 65535 minutes (default: 30 minutes).  
Period interval can be set with LoRaWEB or with downlink command.

### 4.2 Thresholds



On the MCF-LW06424 is possible to set 4 thresholds for each channel:

- Th+ = Threshold High Rising
- Th- = Threshold High Falling
- TI+ = Threshold Low Rising
- TI- = Threshold Low Falling

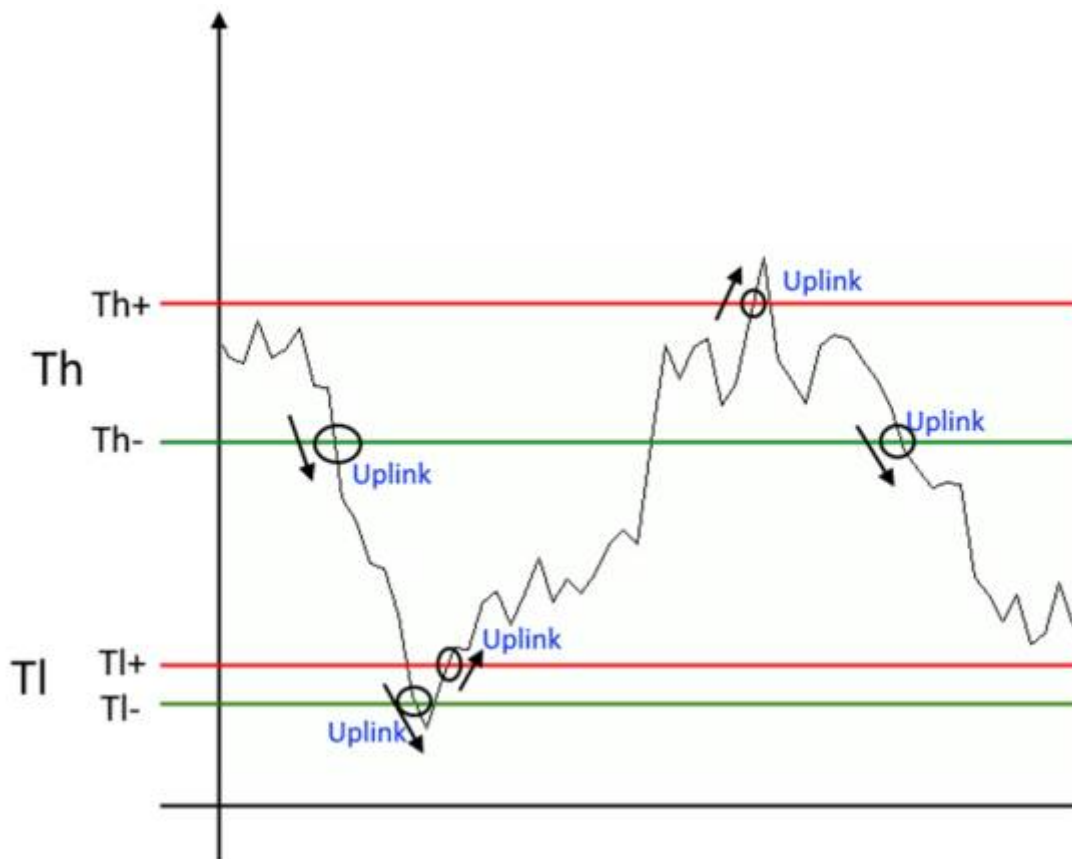

When target values are rising and exceed the positive thresholds, the device sends an uplink with the the latest measure.

When values are falling below the negative thresholds, the device sends a new uplink with the latest measure.

Thresholds can be enabled, disabled and changed va USB with LoRaWEB or with downlinks:

		Channel 1 thresholds high enabled		Channel 2 thresholds high disabled	
		1	Disable	2	Enable
Threshold value (in bits)		Bit	mA	Bit	mA
Threshold High	+	3072 Th+	16.003	0	4.000
	-	2048 Th-	12.002	0	4.000
		1	Disable	2	Enable
Threshold Low	+	1024 Tl+	8.001	0	4.000
	-	512 Tl-	6.000	0	4.000

### 4.3 Other settings

**DST:**

set to change DST (default: none).

**Time sync uplink:**

set to disable time synchronization request (default: enabled).



Normally sensor asks for a time sync at every power on (uplink starting with 01) or once a week. If no

or wrong reply received, it will retry after 1 week.

If not handled in the right way can generate unnecessary traffic on the network.

Please check chapter 2.1 [DATA FRAME FORMAT](#).

### Confirmed Uplinks:

set for unconfirmed uplinks (default: confirmed uplink).

### Single join/day:

set for to allow only one join per day (default: multiple join allowed).

### LED working:

Set OFF to turn off the diagnostic led.

### USB:

Internal use.

## 5. Diagnostic

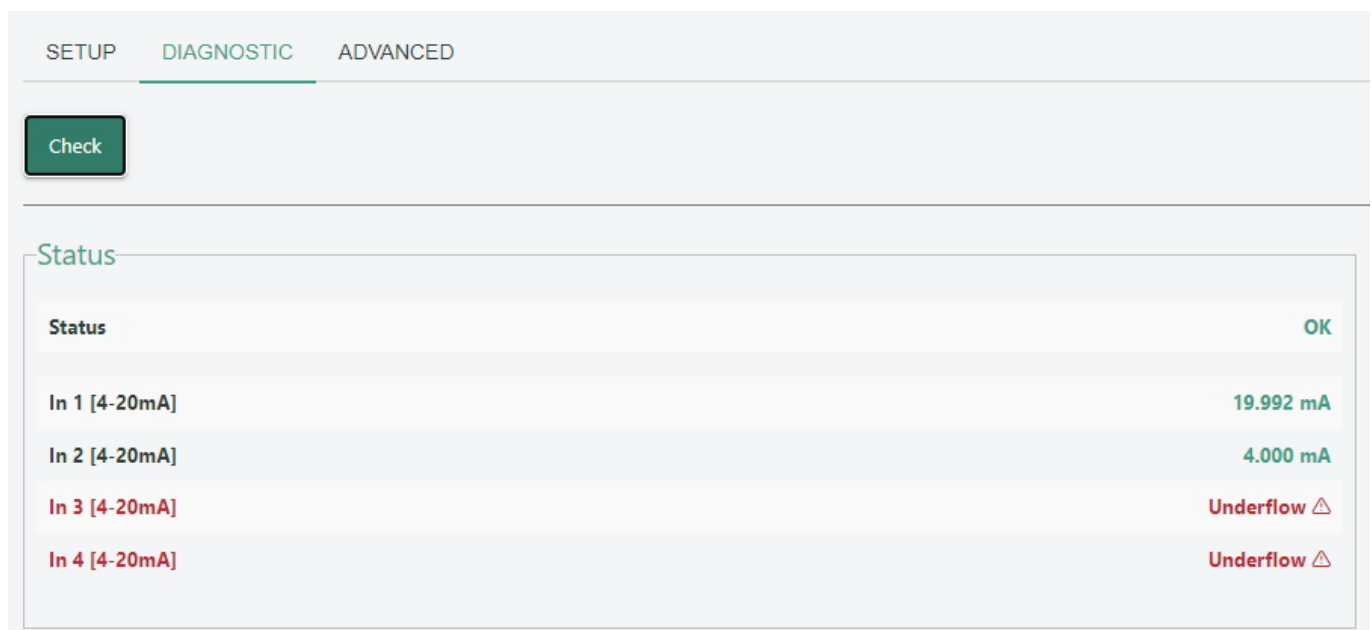

The screenshot shows a web interface with three tabs: 'SETUP', 'DIAGNOSTIC', and 'ADVANCED'. The 'DIAGNOSTIC' tab is active. Below the tabs is a green 'Check' button. Underneath the button is a 'Status' section containing a table with the following data:

Status	OK
In 1 [4-20mA]	19.992 mA
In 2 [4-20mA]	4.000 mA
In 3 [4-20mA]	Underflow <span>⚠</span>
In 4 [4-20mA]	Underflow <span>⚠</span>

Press **Check** to see the analog values.

## 6 LoRaWAN network

The sensor is compliant with LoRaWAN® **specification 1.0.2, regional 1.0.2b**.

### LoRaWAN® Parameters

**LoRaWAN®**

<b>Network Key</b>	<b>App Key</b>
<input type="text"/>	<input type="text"/>
<b>Device Address</b>	
<input type="text"/>	
<b>AppEUI</b>	<b>DevEUI</b>
<input type="text"/>	<input type="text"/>
<b>LoRa Band</b>	
EU 868 MHz - Europe	
<b>LoRaWAN® Activation</b>	
<input type="radio"/> NONE <input type="radio"/> OTAA MCF88 <input type="radio"/> OTAA ENGINKO <input checked="" type="radio"/> OTAA <input type="radio"/> ABP	
<b>Network settings</b>	
<input checked="" type="radio"/> Any <input type="radio"/> Objenious	
<b>Network type</b>	
<input checked="" type="radio"/> Public Network <input type="radio"/> Private Network	

## 6.1 Activation

The device supports the following activations on a LoRaWAN® network:

1. **NONE**: sensor not activated
2. **OTAA**: the JoinEUI and the AppKey not setted, must be written to the device;
3. **OTAA MCF88**: Over the air activation, fixed keys: JoinEUI = 904e915000000002, AppKey on request;
4. **OTAA ENGINKO**: Over the air activation, fixed keys: JoinEUI = 904e915000000002, AppKey on request;
5. **ABP**: requires writing to the device of NwkSkey, AppSkey, DevAddr.



The device exits factory activated with **NONE** mode. On request devices can be shipped already activated.

Note: in **OTAA** AppKey is write only, in reading the field will always be empty, even if set.

## 6.2 Other settings

### Network settings:

please keep "Any" settings. Change it only if Objenious network is used (default\_ any).

### Network type:

LoRa syncword can be setted as "private"(0x12) instead "public" (0x34), but the NS must be setted accordingly (default: public).

### Band:

select the right LoRaWAN ® band settings accodingly to country requirements.

## 7 Passwords

The device can be protected by passwords, to avoid unauthorized persons to read data or modify parameters.

As default passwords are equal to 0.

Allowed values range from 0 to 999999999 (only numbers).

To change the passwords, set the new values with LoRaWEB:

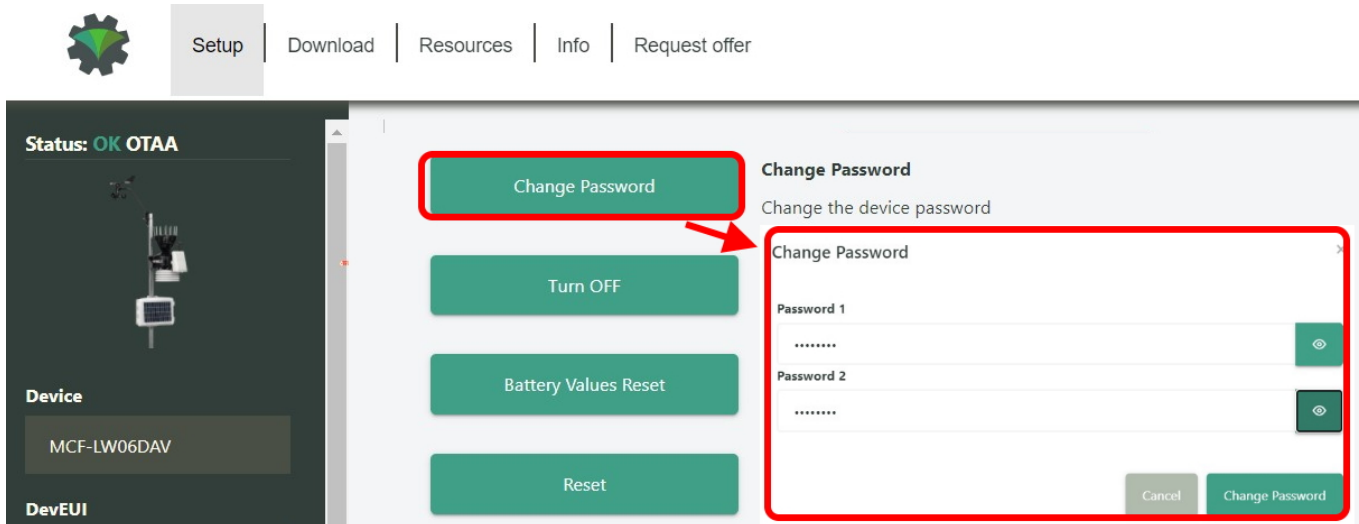

Once the passwords are setted, to gain access from LoRaWEB to the sensor, set the right values before reading from the device:

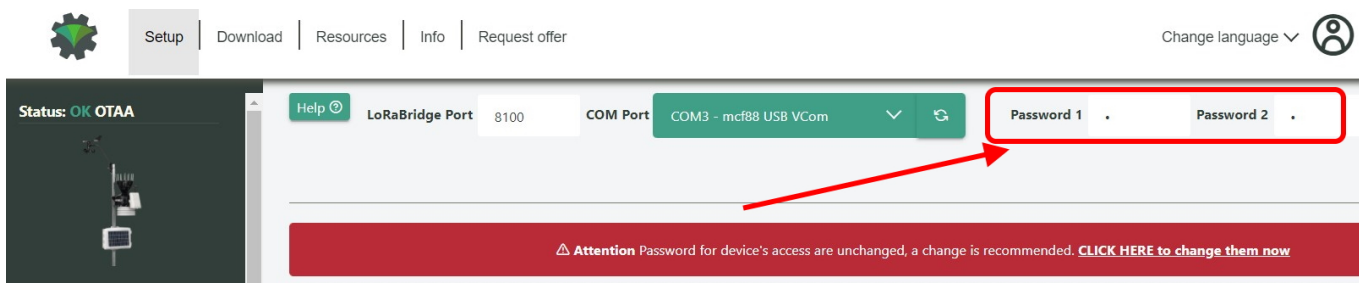

To bring back the sensor to factory default and reset the passwords, a reset code must be requested to enginko (please provide the DevEUI of the sensor when you ask for that code).

## 8 General configuration file

With LoRaWEB is possible to configure the device using an XML file, instead to manually adjust the parameters (for details about the file format please ask to enginko). This is very useful especially in case of multiple devices configuration.

With "Save" button an XML file with the actual configuration of the sensor will be generated. This is useful to store or clone the configuration, or to send it to enginko's support if needed.

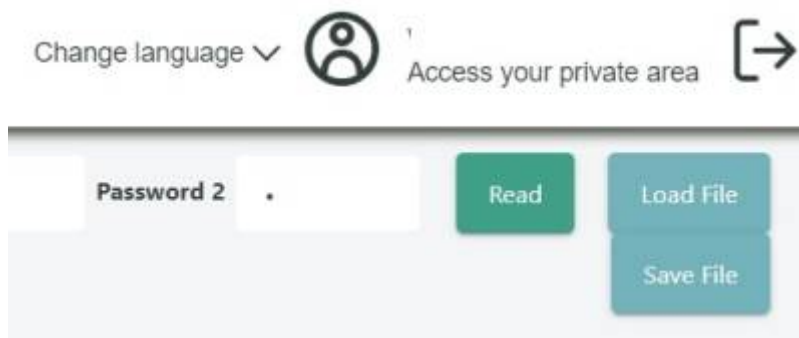

## 8.1 Multi devices configuration

With LoRaWEB is possible to configure many devices in an easy way.

For multi-configuration is needed at least one XML file with the parameters to set.

Settings on this file will be applied to all the sensors.

With an additional XLS file is possible to load different LoRa configuration parameters (Activation Type, AppKey, AppEUI, NetKey, DevAddress, Band, Private option) for each sensor, based on DevEUI.

XLS is prevailing on the XML, so if both files are enabled, if the DevEUI of the device matches one of the DevEUIs in the XLS file, LoRa parameters will be setted from this one.

These configuration can be done in the in the Settings:

- Use of the general configuration by file;
- Use of the specific configuration by file.

**Configure from file**

This feature allows you to configure a device via Excel files (.xls) and XML

**Configure**

**Check Excel files**

Yes  No

**Upload Excel files (.xls) for LoRaWAN® parameters configuration**

Choose File ... **Load File**

[Download Excel template \(.xls\) for a LoRaWAN® specific configuration by DevEUI](#)

---

**Check XML file**

Yes  No

**Upload XML file for the generic configuration of the device**

Choose File ... **Load File**

For details on files format please ask to enginko.

## 9 Payload

For payload descriptions, uplinks and downlinks format and available commands please refer to this document:

[DATA FRAME FORMAT](#)

## 10 Ordering code

Code	Description
MCF-LW06424	4-20mA to LoRaWAN® interface EU863-870
MCF-LW06424-AS	4-20mA to LoRaWAN® interface AS920-925
MCF-LW06424-US	4-20mA to LoRaWAN® interface US902-928
MCF-LW06424-AU	4-20mA to LoRaWAN® interface AU915-928

For payload descriptions, uplinks and downlinks format and available commands please refer to this document:

[DATA FRAME FORMAT](#)

## 11 Declaration of conformity

Hereby, enginko Srl declares that MCF-LW06424 complies with the essential requirements and other relevant provisions of Directive 2014/53/EU.

## 12 FCC compliance for MCF-LW06424-US

This device complies with part 15 of the FCC Rules. Operation is subject to the following two conditions: (1) This device may not cause harmful interference, and (2) this device must accept any interference received, including interference that may cause undesired operation.

This equipment has been tested and found to comply with the limits for a Class B digital device, pursuant to part 15 of the FCC Rules. These limits are designed to provide reasonable protection against harmful interference in a residential installation. This equipment generates, uses and can radiate radio frequency energy and, if not installed and used in accordance with the instructions, may cause harmful interference to radio communications. However, there is no guarantee that interference will not occur in a particular installation. If this equipment does cause harmful interference to radio or television reception, which can be determined by turning the equipment off and on, the user is encouraged to try to correct the interference by one or more of the following measures:

- Reorient or relocate the receiving antenna.
- Increase the separation between the equipment and receiver.
- Connect the equipment into an outlet on a circuit different from that to which the receiver is connected.

- Consult the dealer or an experienced radio/TV technician for help.

Any changes or modifications not expressly approved by the party responsible for compliance could void the user's authority to operate this equipment.

**Contains FCC ID: 2AWAL409810**

## 13 Contacts

### **enginko Srl**

Via Roma 3 I-28060 Sozzago (NO)

T : +39 0321 15 93 088

E : [info@enginko.com](mailto:info@enginko.com)

PEC: [enginkosrl@legalmail.it](mailto:enginkosrl@legalmail.it)

W: [enginko.com](http://enginko.com)

---

rev.0

From:

<https://www.enginko.com/support/> - **enginko.support.center**

Permanent link:

[https://www.enginko.com/support/doku.php?id=manual\\_mcf-lw06424&rev=1644992544](https://www.enginko.com/support/doku.php?id=manual_mcf-lw06424&rev=1644992544)

Last update: **2023/05/29 07:33**

