

Table of Contents

- MCF-LW06DAVK/DAVPK Operating Manual** 1
- 1. Description** 1
- 2. Overview** 2
 - 2.1 Technical data 2
 - 2.2 Installation 3
 - 2.3 Configuration 6
 - 2.4 System led 7
 - 2.5 Firmware update 8
- 3. Setup** 8
 - 3.1 Period 9
 - 3.2 Altitude compensation 9
 - 3.3 Other settings 9
- 4. Diagnostic** 10
- 5 LoRaWAN network** 11
 - 5.1 Activation 12
 - 5.2 Other settings 13
- 6 Passwords** 13
- 7 Configuration file** 14
 - 7.1 Multi devices configuration 15
- 8 Payload** 16
- 9 Maintenance** 16
- 10 Davis references** 16
- 11 Ordering code** 16
- 12 Declaration of conformity** 16
- 13 Contacts** 17



MCF-LW06DAVK/DAVPK Operating Manual

Important safety information



Read this manual before attempting to install the device! Failure to observe recommendations included in this manual may be dangerous or cause a violation of the law. The manufacturer will not be held responsible for any loss or damage resulting from not following the instructions of this operating manual.

- Do not dismantle or modify in any way.
- The device is not intended to be used as a reference sensor, and enginko Srl will not be held liable for any damage which may result from inaccurate readings.
- Avoid mechanical stress
- Do not use any detergent or alcohol to clean the device.

Disposal information for users



Pursuant to and in accordance with Article 14 of the Directive 2012/19/EU of the European Parliament on waste electrical and electronic equipment (WEEE), and pursuant to and in accordance with Article 20 of the Directive 2013/56/EU of the European Parliament on batteries and accumulators and waste batteries.

The barred symbol of the rubbish bin shown on the equipment indicates that, at the end of its useful life, the product must be collected separately from other waste.

For additional information and how to carry out disposal, please contact the certified disposal service providers.

1. Description

MCF-LW06DAVK/DAVPK is a LoRaWAN® communication system kit designed to be connected to Davis Vantage Pro2 Weather Station. The kit is designed to work with these Davis components:

- ISS Davis Vantage Pro2 Groweather sensor suite 6820CM [6820CM](#) or ISS Davis Vantage Pro2 sensor suite 6820CM [6322C](#)
- Cabled Weather Envoy® [6316CEU](#) [6316CEU](#)
- WeatherLink® Serial-Port Data Logger 6510SER [6510SER](#)
- Solar box [6612](#) [6612](#)
- UV sensor 6490(optional) [6490](#)

Further, the MCF-LW06DAVPK kit adds a PM measurement system to the existing Davis station.



2. Overview

Based on the different version, some sensors can be not present.

2.1 Technical data

enginko LoRaWAN® interface kit:

- CPU Cortex M0+
- EEPROM 32Kb
- Flash 64k
- Encryption AES 128 bit
- Class A LoRaWAN® 1.0.2 stack EU868, AS923, AU915, US915
- Transmission band (EU version): 868 MHz
- Transmission Power (EU version): 14dBm max
- USB for IoT node setup, FW upgrade and data reading
- PM sensor PM1\PM2.5 $\pm 10\%$, PM10 $\pm 30\%$

Davis Instruments:

- Temperature range -40°C to $+65^{\circ}\text{C}$ $\pm 0.3^{\circ}\text{C}$
- Relative Humidity from 0% to 100% $\pm 2\%$
- Atmospheric pressure from 880 to 1080 hPa $\pm 1\text{hPa}$
- Rain range 0 to 6553 mm $\pm 4\%$
- Solar Radiation 0 to 1800W/mq $\pm 5\%$
- Wind Speed 0 to 114m/s

- Wind Direction 0° to 360° ±3°
- Dew point and barometric point as derived variables
- 5W Solar panel powered with 6V12Ah battery

2.2 Installation

2.2.1 Assembly of the weather station

Setup the weather station following DAVIS INSTRUMENTS Instructions:

- Sensor suite [6820C](#) or [6322CM](#)
- Solar box [6612](#)
- Cabled Weather Envoy® [6316CEU](#) [6316CEU](#)
- WeatherLink® Serial-Port Data Logger [6510SER](#) [6510SER](#)
- Tripod (if present) [7716A](#)
- Pole kit (if present) [7717](#)
- UV sensor (if present) [6490](#)

Important notes (not exhaustive - please refer to Davis documents for full notes):

- enginko LoRaWAN® interface (MCF-LW06DAV or MCF-LW06DAVP) must be the last device to be powered on.
- On the rain collector, remove the plastic tie that holds the tipping spoon in place during shipping.
- Install the sensor suite (UV sensor, solar radiation sensor, rain collector) as level as possible to ensure accurate measurements.
- In the Northern Hemisphere, the solar panel should face south for maximum sun exposure, and the anemometer arm should point north for proper wind direction calibration.
- In the Southern Hemisphere, the solar panel should face north for maximum sun exposure.

2.2.2 LoRaWAN interface

On the DW-6612 solar panel box proceed as follow (see below image):

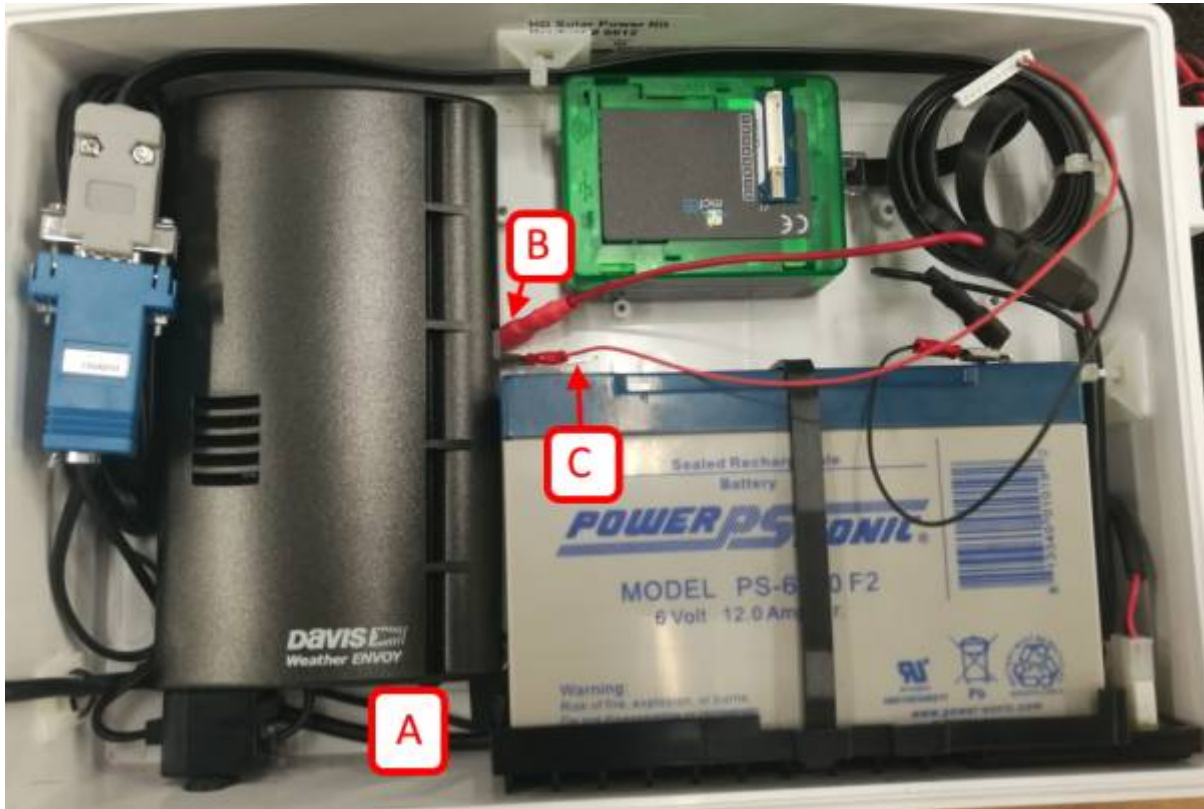

1. Remove the 6316CEU by sliding down-up and pull.
2. Insert provided 4xAA size batteries on the 6316CEU.
3. Connect the “console” cable “A” coming from the 6820CM, by entering the box using the gasket on the bottom side’s hole.
4. Fasten the 6316CEU to the box
5. Connect the red wire terminal “B” to the positive terminal of the battery “C”.
6. Connect the white connector to the LoRaWAN® interface “D”:

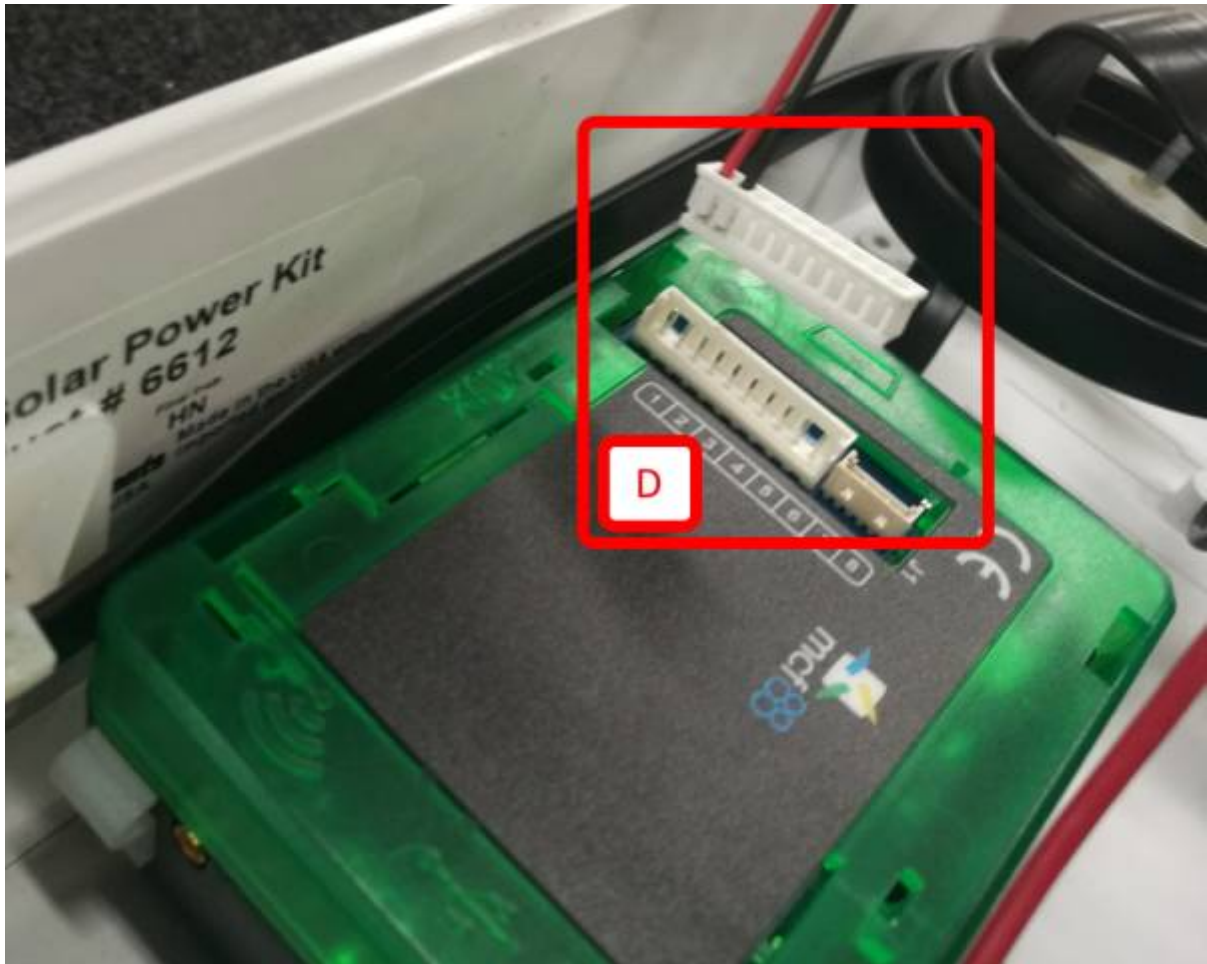

2.2.3 Antenna

Mount the provided antenna on the pole using fasteners. On the DW-6612 solar panel box, connect the antenna connector to the MCF-LW06DAV device (Davis station to LoRaWAN™ interface) as shown below by entering the box using the gasket on the bottom side's hole:

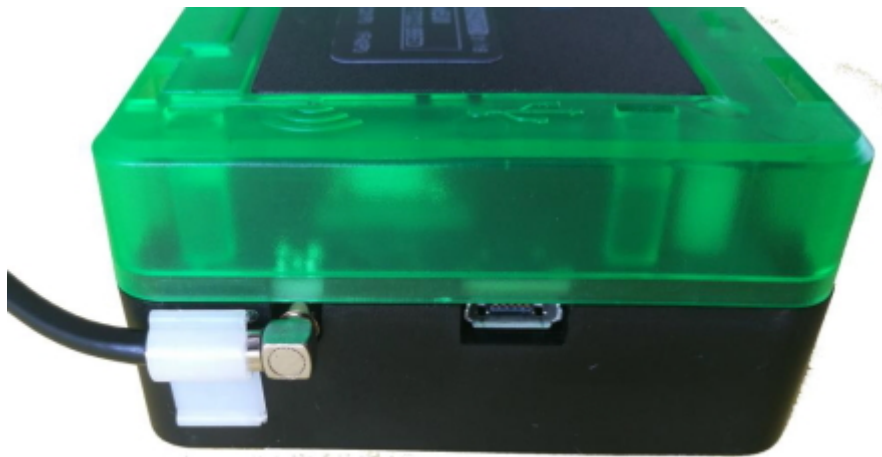

2.2.4 PM sensor (if present)

Mount the solar shield with the PM sensor on the pole (at the back of the DW-6612 solar panel box) following the enclosed instruction:

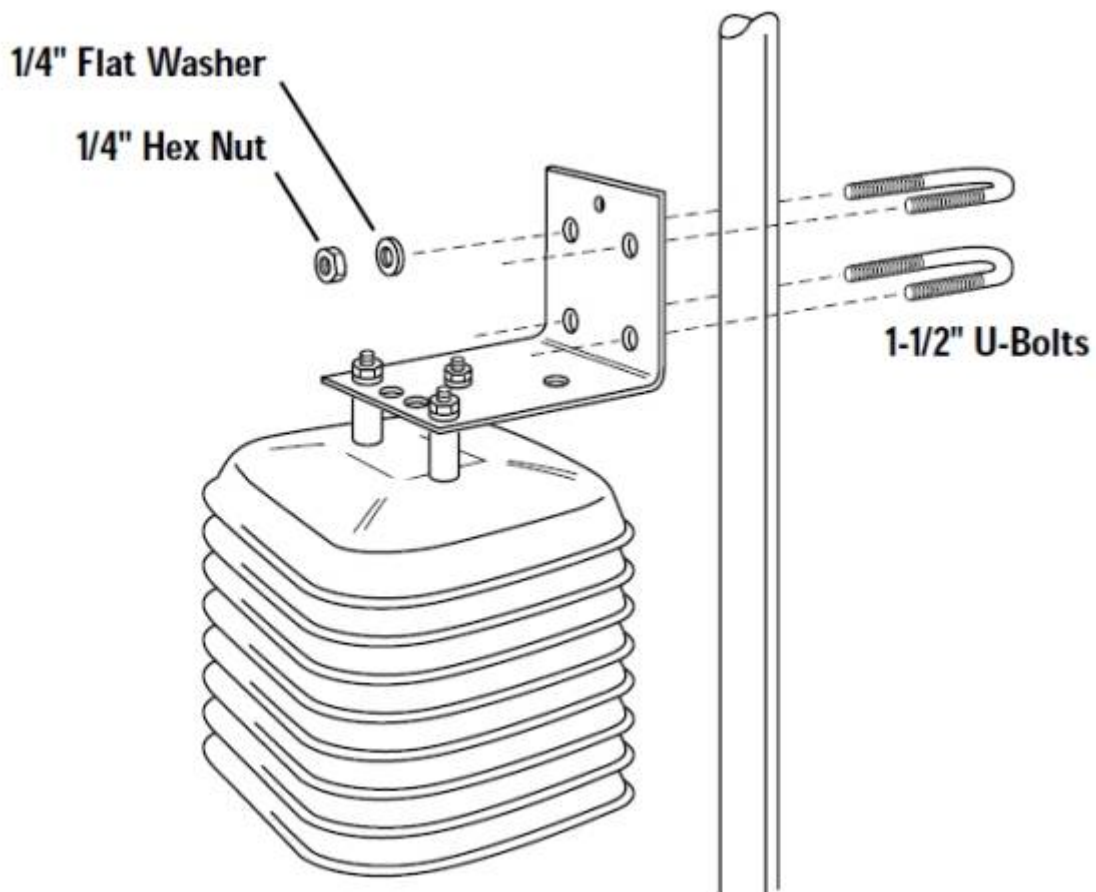

On the Davis 6612 solar panel box, connect the cable to the MCF-LW06DAVP device (Davis station to LoRaWAN™ interface) as shown below by entering the box using the gasket on the bottom side's hole:

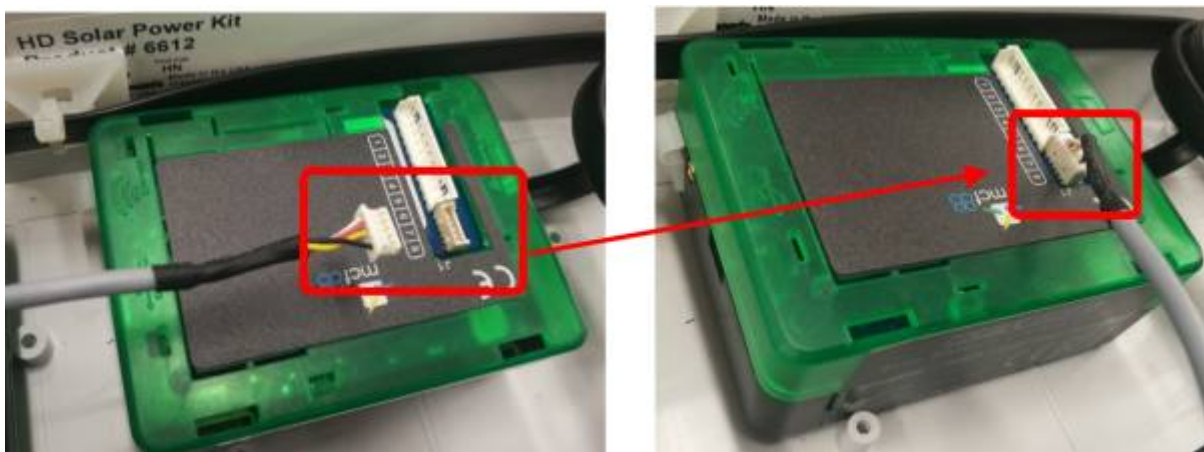

2.3 Configuration

To deploy the sensor, use **LoRaWEB** online tool, to setup LoRaWAN® credentials and other preferences (only available for Windows®) :

[LoRaWEB Tool](https://iot.mcf88.cloud/LoRaWeb) (iot.mcf88.cloud/LoRaWeb)

Before connect the device the first time, please install LoRaBridge applicarions and drivers:

<https://iot.mcf88.cloud/LoRaWeb/#/download>





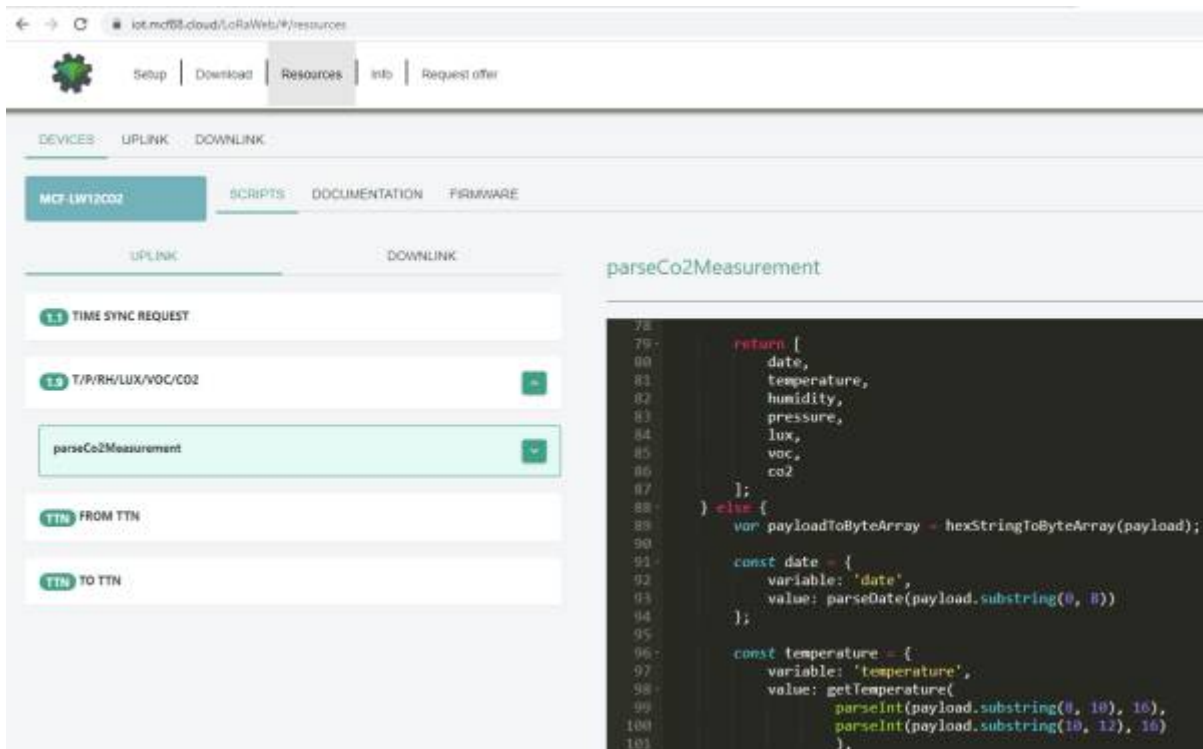
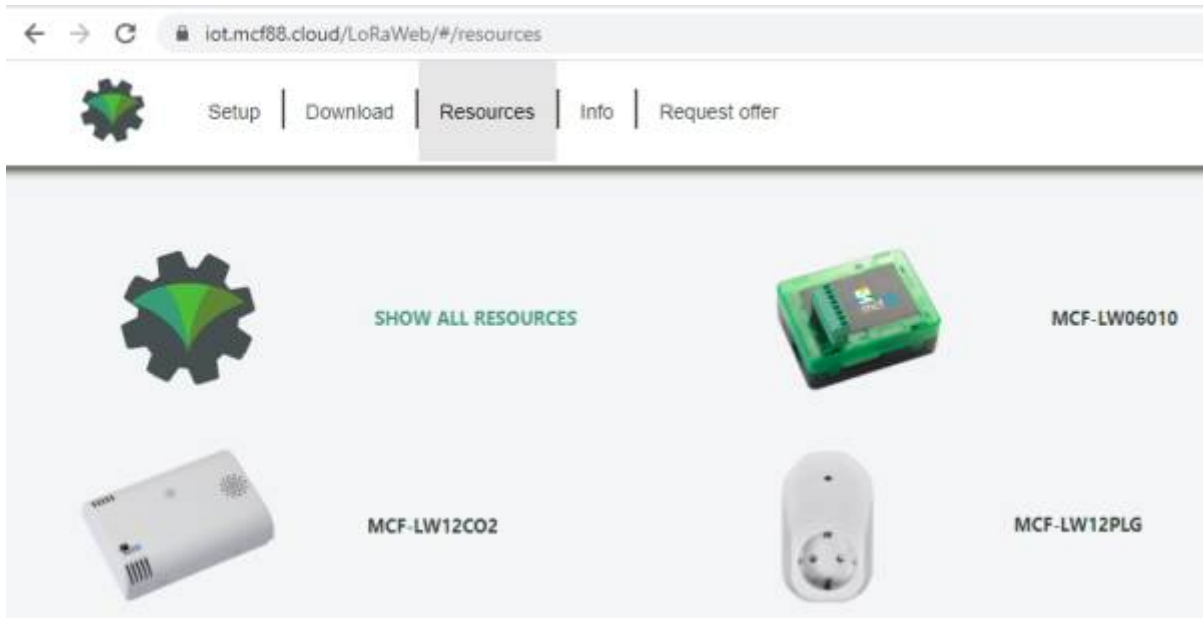

Validate your settings reading data after the write.

enginko provides, upon free registration, user manuals, javascript examples, downlink generator, uplink decoder, firmware updates and different tools :



2.4 System led

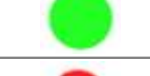

LoRaWAN® not configured		Slow flashing
Joining		Quick flashing
Sending		Quick flashing
Receiving		Quick flashing
Steady state		Fixed
Data error		Flashing 2 seconds
Connection error		Flashing 1 second

2.5 Firmware update

Save the new firmware file (.exe) on the PC, run the file, select the USB FW port and start the update:

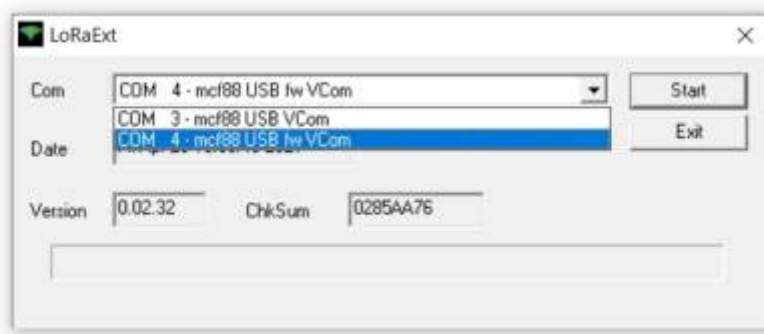

and waiting for the end message.

3. Setup

3.1 Period

Period is the interval (in minutes) between one measure and the next one. The sensor sends one measures for every transmission. Value can be between 15 and 65535 minutes (default: 30 minutes).

Period interval can be set with App or with downlink command.

3.2 Altitude compensation

When the sensor is not installed at the sea level, the reading of barometric pressures at other elevations must be compensated.

Set the right altitude value with LoRaWEB.

Value can be from -300 to 3000 meters.

Altitude can also be set with downlink command.

3.3 Other settings

DST:

set to change DST (default: none).

Time sync uplink:

set to disable time synchronization request (default: enabled).



Normally sensor asks for a time sync at every power on (uplink starting with 01) or once a week. If no or wrong reply received it will retry after 1 hour.

If not handled in the right way can cause a unnecessary battery consumption (battery life < 2 years).

Please check chapter 2.1 [DATA FRAME FORMAT](#).

Confirmed Uplinks:

set for unconfirmed uplinks (default: confirmed uplink).

Single join/day:

set for to allow only one join per day (default: multiple join allowed).

LED working:

Set OFF to turn off the diagnostic led.

USB:

Internal use.

4. Diagnostic

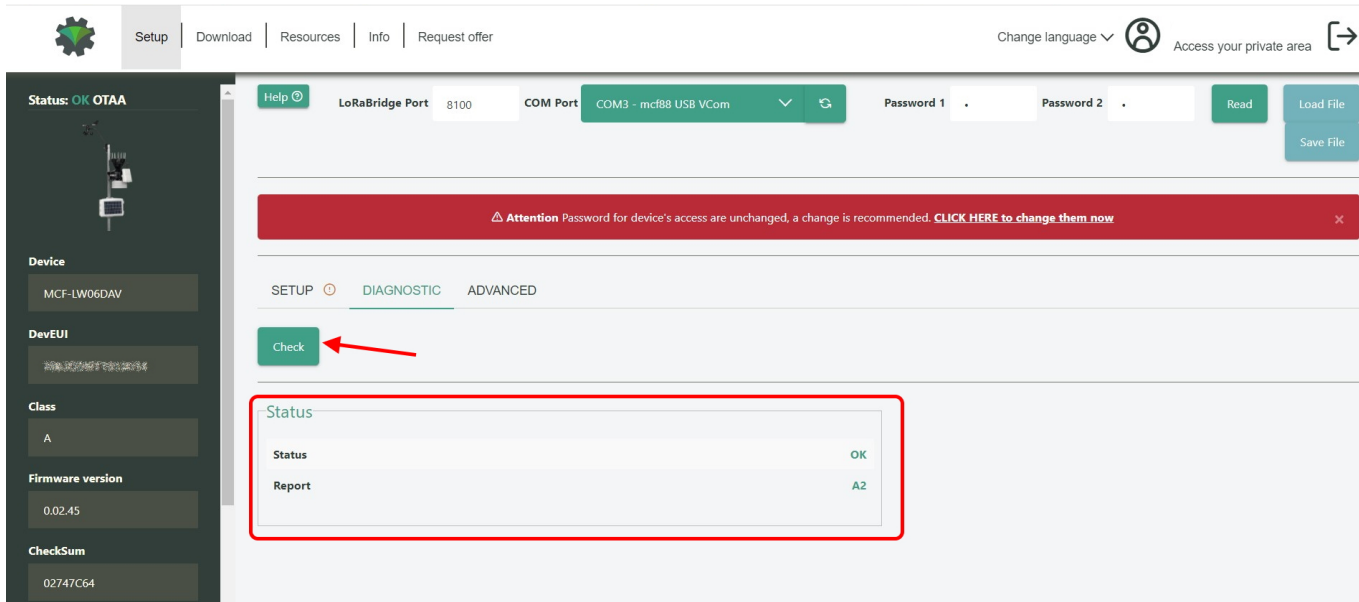

Press **Check** to verify the correct communication between the LoRaWAN® interface and the Davis envoy.

5 LoRaWAN network

The sensor is compliant with LoRaWAN® **specification 1.0.2, regional 1.0.2b.**

LoRaWAN® Parameters



LoRaWAN®

Network Key	App Key
<input type="text"/>	<input type="text"/>
Device Address	<input type="text"/>
AppEUI	DevEUI
<input type="text"/>	<input type="text"/>
LoRa Band	
EU 868 MHz - Europe	
LoRaWAN® Activation	
<input type="radio"/> NONE <input type="radio"/> OTAA MCF88 <input type="radio"/> OTAA ENGINKO <input checked="" type="radio"/> OTAA <input type="radio"/> ABP	
Network settings	
<input checked="" type="radio"/> Any <input type="radio"/> Objenious	
Network type	
<input checked="" type="radio"/> Public Network <input type="radio"/> Private Network	

5.1 Activation

The device supports the following activations on a LoRaWAN® network:

1. **NONE**: sensor not activated
2. **OTAA**: the JoinEUI and the AppKey not setted, must be written to the device;
3. **OTAA MCF88**: Over the air activation, fixed keys: JoinEUI = 904e915000000002, AppKey on request;
4. **OTAA ENGINKO**: Over the air activation, fixed keys: JoinEUI = 904e915000000002, AppKey on request;
5. **ABP**: requires writing to the device of NwkSkey, AppSkey, DevAddr.

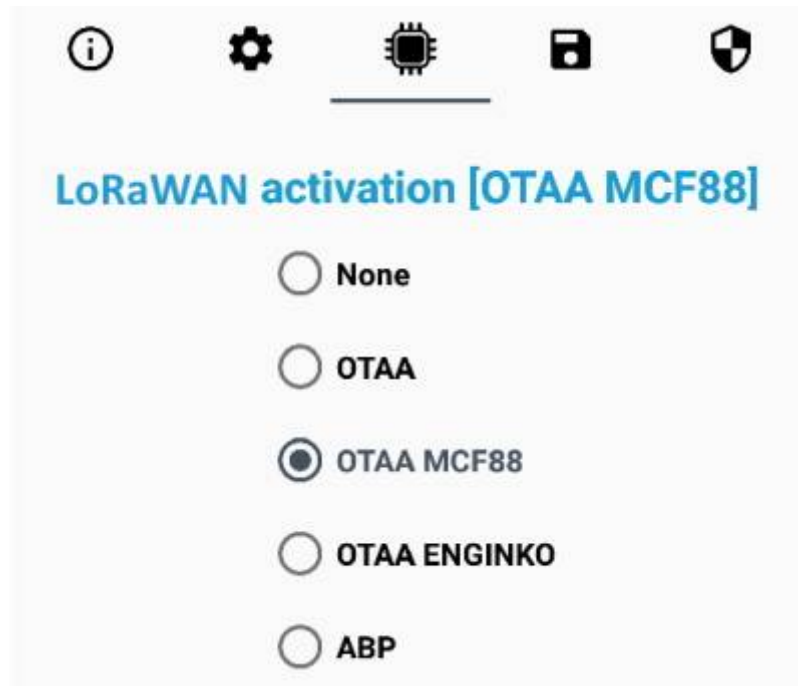

The device exits factory activated with **NONE** mode. On request devices can be shipped already activated.

Note: in **OTAA** AppKey is write only, in reading the field will always be empty, even if set.

5.2 Other settings

Network settings:

please keep "Any" settings. Change it only if Objenious network is used (default_ any).

Network type:

LoRa syncword can be setted as "private"(0x12) instead "public" (0x34), but the NS must be setted accordingly (default: public).

Band:

select the right LoRaWAN ® band settings accodngly to country requirements.

6 Passwords

The device can be protected by passwords, to avoid unauthorized persons to read data or modify parameters.

As default passwords are equal to 0.

Allowed values range from 0 to 999999999 (only numbers).

To change the passwords, set the new values with LoRaWEB:

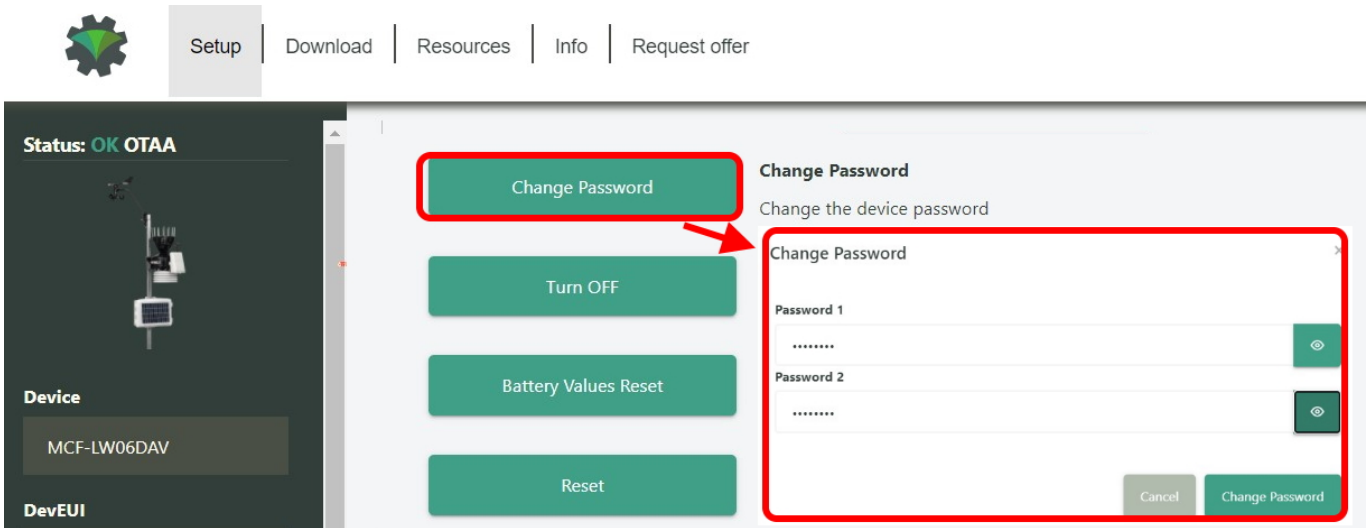

Once the passwords are setted, to gain access from LoRaWEB to the sensor, et the right values before reading from the device:

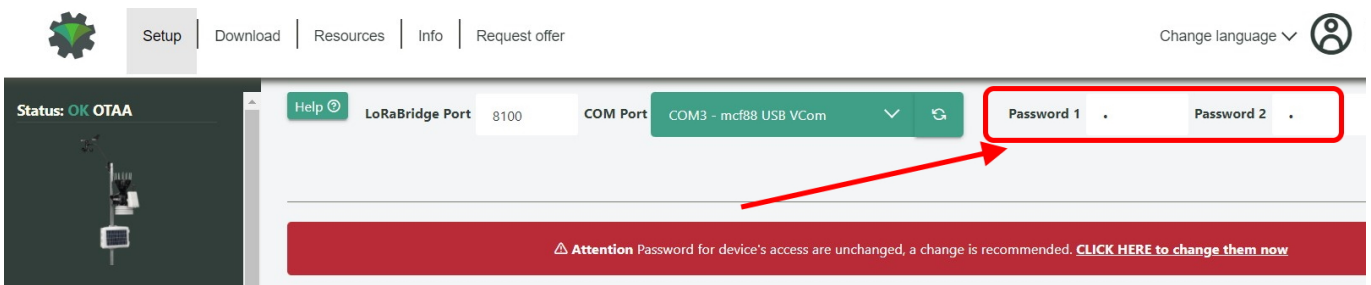

To bring back the sensor to factory default and reset the passwords, a reset code must be requested to enginko (please provide the DevEUI of the sensor when you ask for that code).

7 Configuration file

With LoRaWEB is possible to configure the device using an XML file, instead to manually adjust the parameters (for details about the file format please ask to enginko). This is very useful especially in case of multiple devices configuration.

With "Save" button an XML file with the actual configuration of the sensor will be generated. This is useful to store or clone the configuration, or to send it to enginko's support if needed.

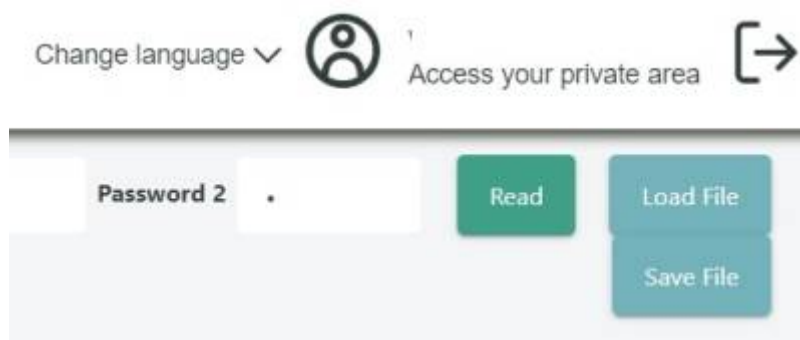

7.1 Multi devices configuration

With LoRaWEB is possible to configure many devices in an easy way.

For multi-configuration is needed at least one XML file with the parameters to set.

Settings on this file will be applied to all the sensors.

With an additional XLS file is possible to load different LoRa configuration parameters (Activation Type, AppKey, AppEUI, NetKey, DevAddress, Band, Private option) for each sensor, based on DevEUI.

XLS is prevailing on the XML, so if both files are enabled, if the DevEUI of the device matches one of the DevEUIs in the XLS file, LoRa parameters will be setted from this one.

These configuration can be done in the in the Settings:

- Use of the general configuration by file;
- Use of the specific configuration by file.

Configure from file

This feature allows you to configure a device via Excel files (.xls) and XML

Configure

Check Excel files

Yes No

Upload Excel files (.xls) for LoRaWAN® parameters configuration

Choose File ... **Load File**

[Download Excel template \(.xls\) for a LoRaWAN® specific configuration by DevEUI](#)

Check XML file

Yes No

Upload XML file for the generic configuration of the device

Choose File ... **Load File**

For details on files format please ask to enginko.

8 Payload

For payload descriptions, uplinks and downlinks format and available commands please refer to this document:

[DATA FRAME FORMAT](#)

9 Maintenance

Please follow the instructions provided by Davis instruments:

[DAVIS INSTRUMENTS VANTAGE PRO 2 MAINTENANCE](#)

10 Davis references

10.1 Sensors data

[station_sensors_specs.pdf](#)

10.2 Derived weather variables

[AN_28-derived-weather-variables](#)

11 Ordering code

Code	Description
MCF-LW06DAVK	enginko Davis to LoRaWAN® interface kit EU863-870
MCF-LW06DAVK-AS	enginko Davis to LoRaWAN® interface kit AS920-925
MCF-LW06DAVK-US	enginko Davis to LoRaWAN® interface kit US902-928
MCF-LW06DAVK-AU	enginko Davis to LoRaWAN® interface kit AU915-928
MCF-LW06DAVPK	enginko Davis to LoRaWAN® interface kit with PM sensor EU863-870
MCF-LW06DAVPK-AS	enginko Davis to LoRaWAN® interface kit with PM sensor AS920-925
MCF-LW06DAVPK-US	enginko Davis to LoRaWAN® interface kit with PM sensor US902-928
MCF-LW06DAVPK-AU	enginko Davis to LoRaWAN® interface kit with PM sensor AU915-928

12 Declaration of conformity

Hereby, enginko Srl declares that MCF-LW06DAVK/DAVPK complies with the essential requirements and other relevant provisions of Directive 2014/53/EU.

13 Contacts

enginko Srl

Via Roma 3 I-28060 Sozzago (NO)

T : +39 0321 15 93 088

E : info@enginko.com

PEC: enginkosrl@legalmail.it

W: enginko.com

rev.0

From:

<https://www.enginko.com/support/> - **enginko.support.center**

Permanent link:

https://www.enginko.com/support/doku.php?id=manual_mcf-lw06davk_davpk&rev=1654602687

Last update: **2023/05/29 07:33**

